

Dolphin WAVE 100 Pool Cleaner

Operating Instructions



Dolphin WAVE 100 Robotic Pool Cleaner

Operating Instructions

Contents

- 1. INTRODUCTION 2
- 2. SPECIFICATIONS 2
- 3. WARNINGS AND CAUTIONS..... 2
 - 3.1. Warnings 2
 - 3.2. Cautions 2
- 4. POOL CLEANER PARTS..... 3
- 5. USING THE POOL CLEANER..... 4
 - 5.1. Set up 4
 - 5.2. Putting the Pool Cleaner into the pool 5
 - 5.3. Removing the Pool Cleaner from the pool 5
 - 5.4. Maintenance 6
 - 5.5. Off-season storage..... 7
- 6. POWER SUPPLY 8
- 7. REMOTE CONTROL UNIT 9
- CADDY ASSEMBLY 11

Dolphin WAVE 100 Pool Cleaner

Operating Instructions

1. INTRODUCTION

Thank you for purchasing a Maytronics Robotic Pool Cleaner.

We are sure that your Maytronics Robotic Pool Cleaner will provide you with reliable, convenient and cost effective pool cleaning. Its reliable filtration in all pool conditions and all-surface climbing brush enhance maximum pool hygiene.

The Robotic Pool Cleaners by Maytronics deliver advanced cleaning technology, long lasting performance and easy maintenance.

2. SPECIFICATIONS

Motor protection: IP 68

Minimum depth: 0.4 m (1.33 ft)

Maximum depth: 5 m (16.4 ft)

3. WARNINGS AND CAUTIONS

3.1. Warnings



- Use the originally supplied power supply only
- Ensure the electrical outlet is protected by a ground fault interrupter (GFI) or an earth leakage interrupter (ELI)
- Keep the power supply out of standing water
- Position the power supply at least 3.5 m (12 ft) away from the edge of the pool
- Do not enter the pool while the pool cleaner is working
- Unplug the power supply before servicing
- Keep the Robotic Pool Cleaner out of the reach of children or persons with reduced physical, sensory, or mental capabilities, or lack of experience and knowledge, unless they have been given supervision or instruction.

3.2. Cautions

When not in use store the Pool Cleaner on the Caddy in a shaded area.

Use the Pool Cleaner in the following water conditions only:

Chlorine	4 ppm max.
pH	7.0 – 7.8
Temperature	6 °C – 35 °C (43 °F – 95 °F)
NaCl	5000 ppm max.

4. POOL CLEANER PARTS

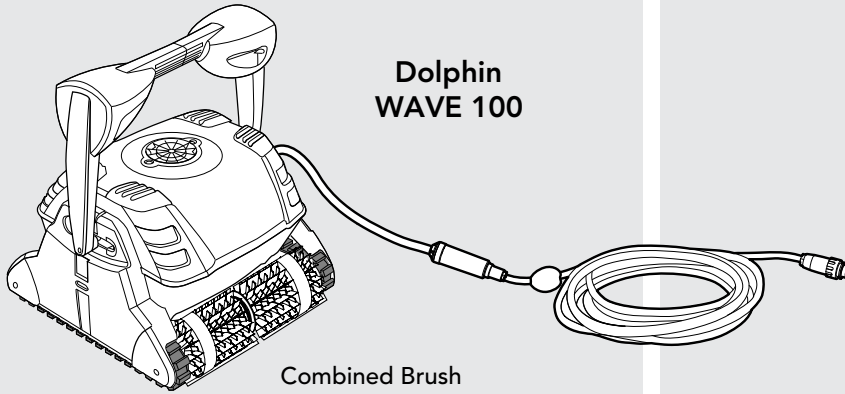

**Dolphin
WAVE 100**

Combined Brush
All surface climbing
brush ideal for most
pool surfaces

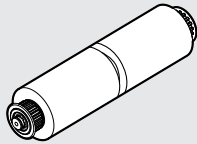

Wonder Brush
For smooth ceramics
(optional)

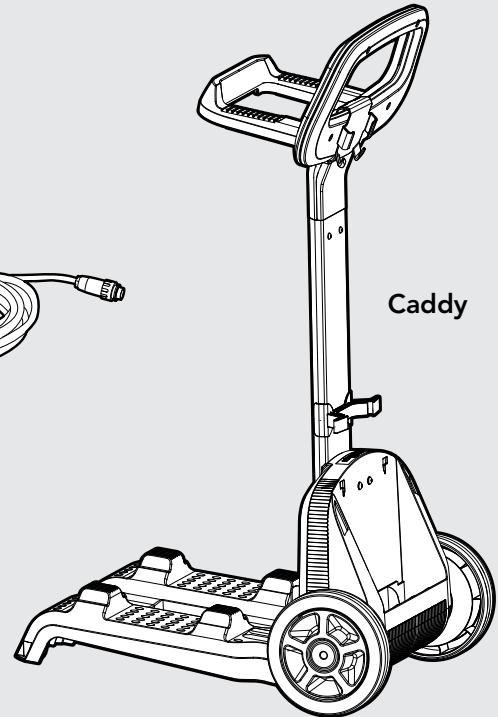

Caddy

Bottom lid and filter Bag

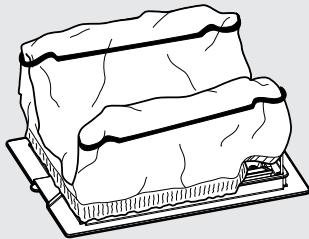

Filter bag options:
Fine - factory default
Ultra fine - extra
Disposable filter bag x 5



Remote Control Unit

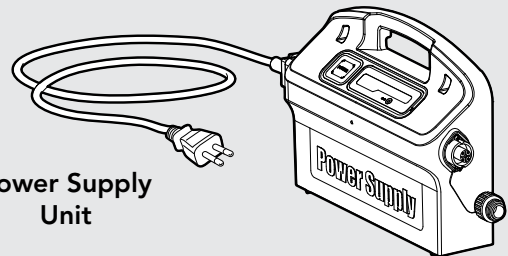

**Power Supply
Unit**

5. USING THE POOL CLEANER

5.1. Set Up

Before using the Pool Cleaner for the first time perform the following steps.

Unwind the cable and stretch it out completely so that it has no kinks.

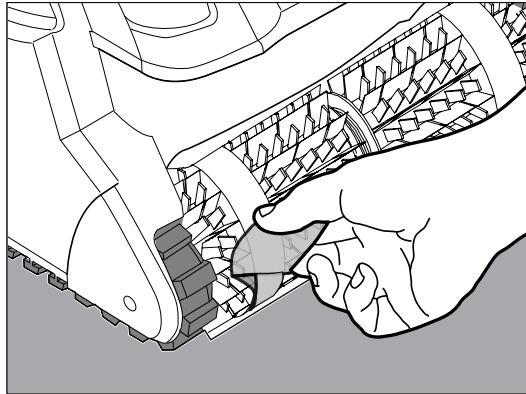
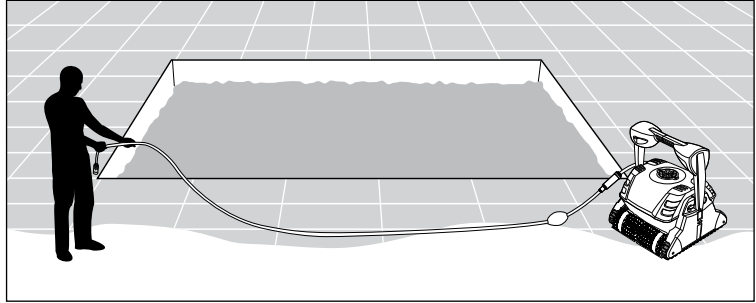

Remove the plastic coverings before use.

Attach the floating cable to the power supply by inserting it with the notch on the connector (1) lined up with the groove in the socket on the power supply and turning clockwise (2).

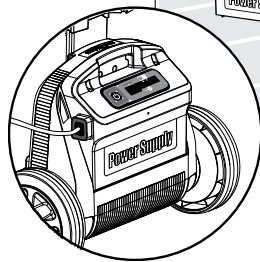
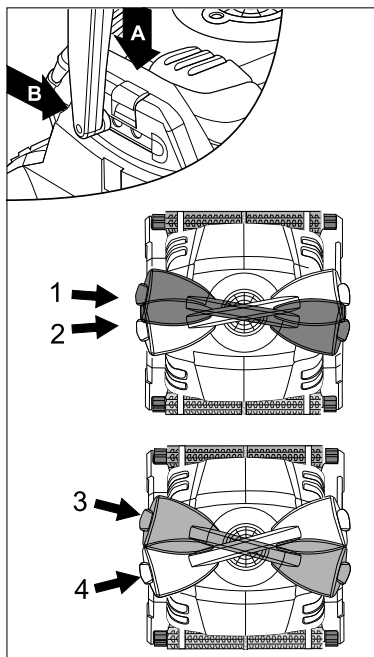
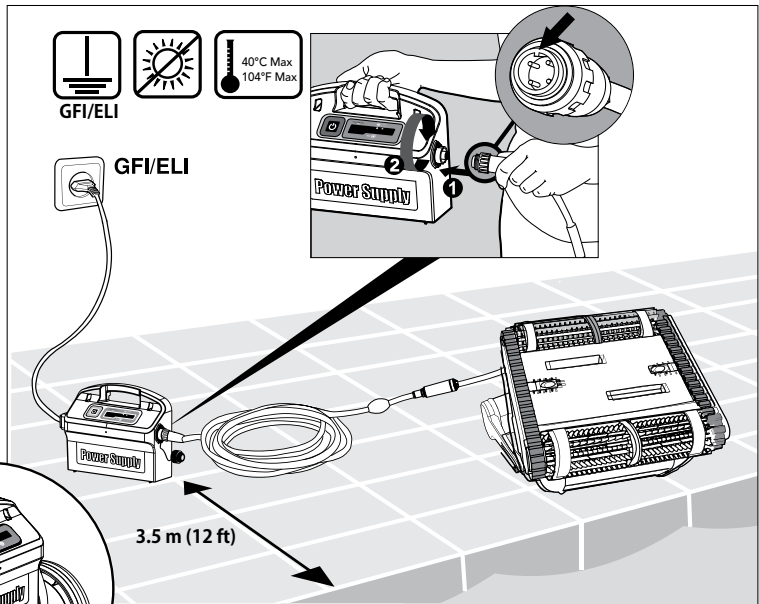

Change diagonal handle position for water line sideways movement.

To adjust the handle angle:

- A. Press the latch down and hold it in position.
- B. Move the handle to the desired position and release the latch to hold the handle in place.

1,2: Normal advance
More efficient cleaning action on water-line.

3,4: Fast advance
Fast speed – for faster but less efficient cleaning action on water-line.

5.2. Putting the Pool Cleaner into the pool

If the foam climbing rings on the brushes are dry soak them in water until soft.

Shake the robot from side to side or turn it upside down to release trapped air. Let it sink to the pool floor.

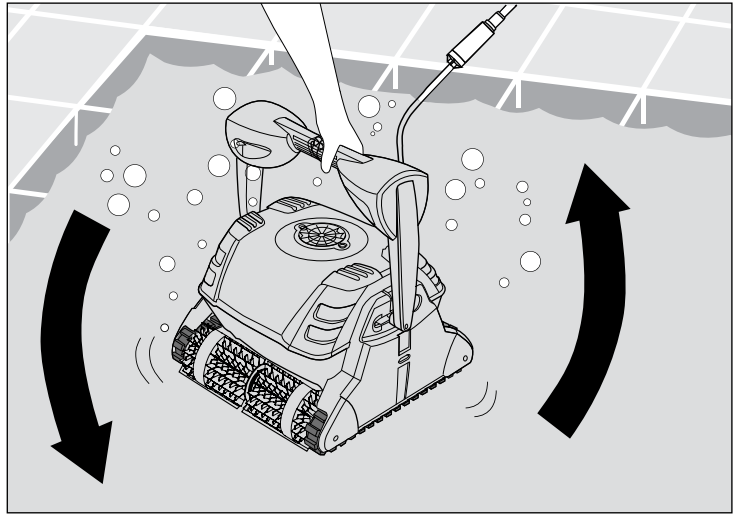

Turn the power supply ON.

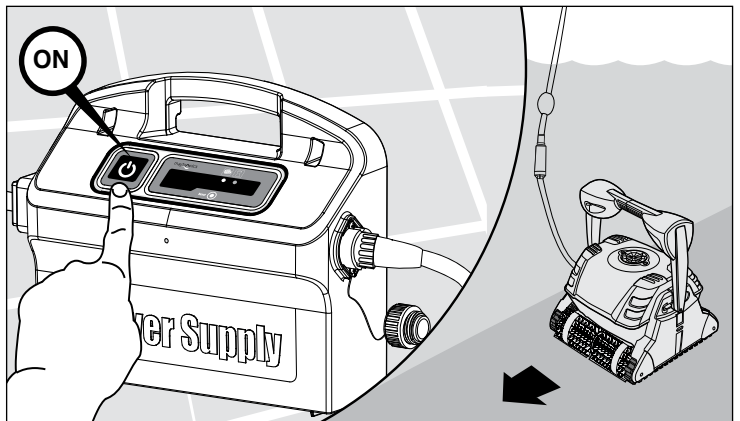

5.3. Removing the Pool Cleaner from the pool

The robot will perform automatic shut-off at the end of the cleaning cycle.

 Turn OFF and unplug the power supply.

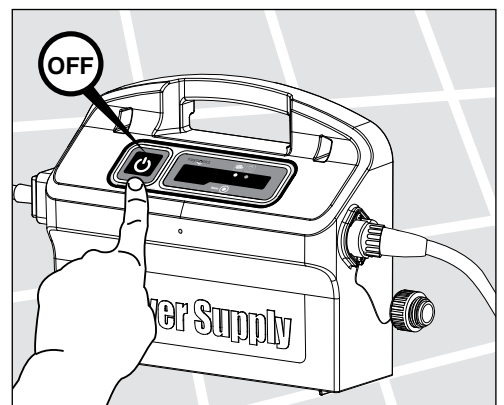

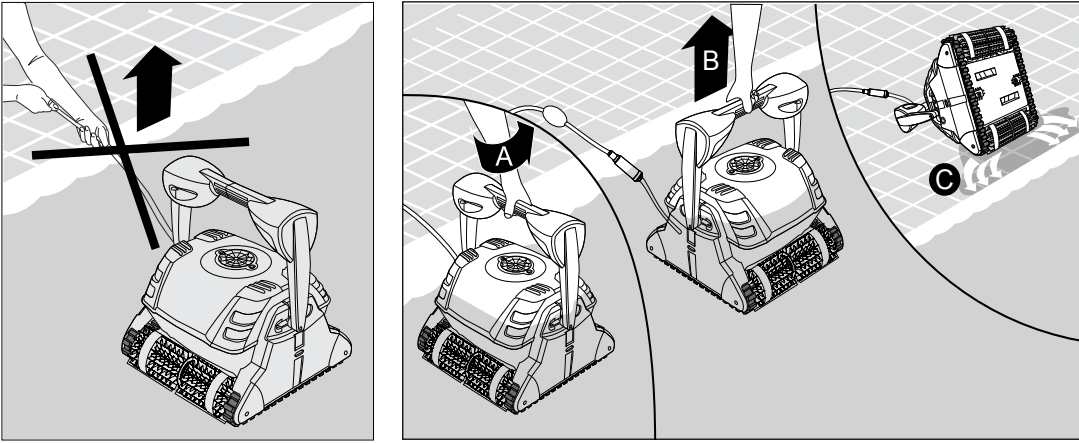

Using the floating cable, bring the Pool Cleaner to the pool's edge.

! DO NOT PULL THE POOL CLEANER FROM THE POOL USING THE CABLE.

5.4. Maintenance

Clean the filter bag with a hose.
 Periodically clean the brushes with a hose.
 It is recommended to periodically wash
 the filter bag in a washing machine.
 Use gentle cycle program.

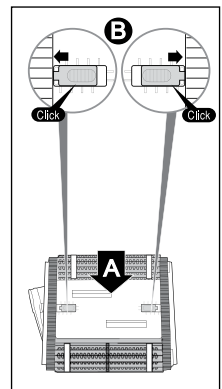
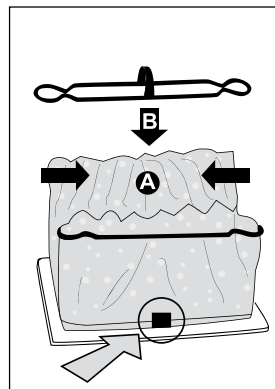
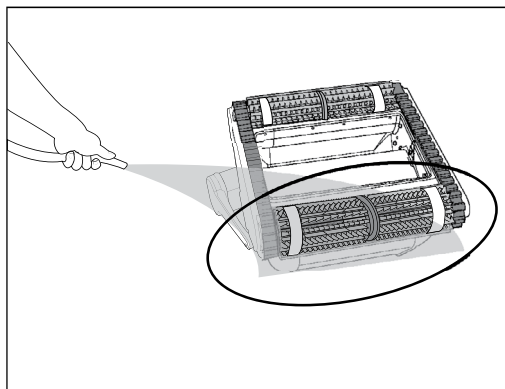
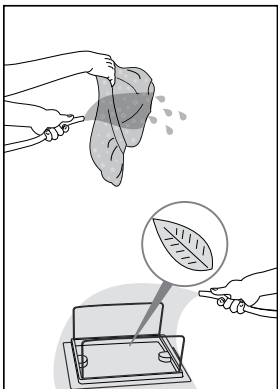
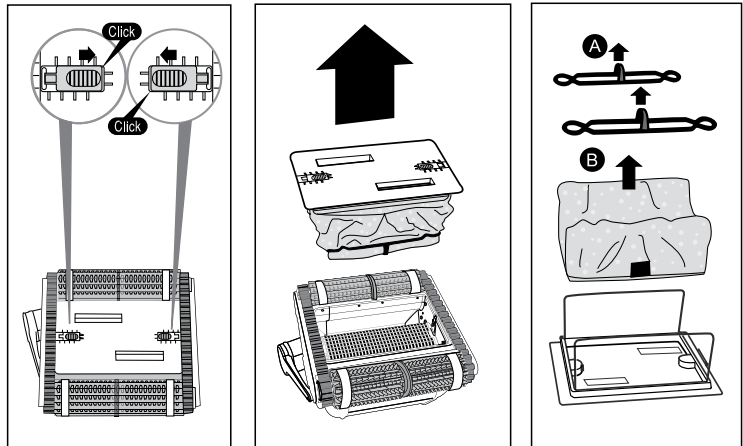

Cleaning the impeller

 **Unplug the power supply.**

If you notice debris trapped in the impeller, open the impeller and remove the debris.

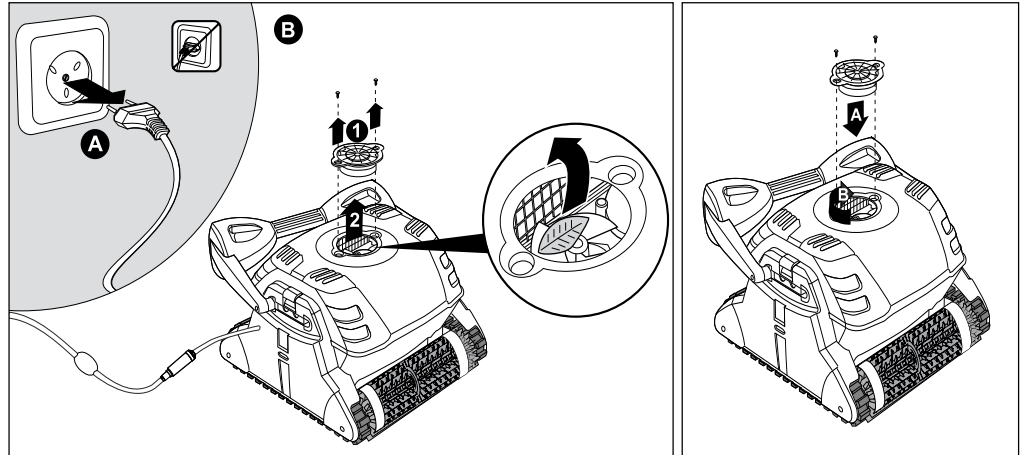

Cable

To remove the kinks, stretch the cable out completely and let it sit for at least a day in the sun.

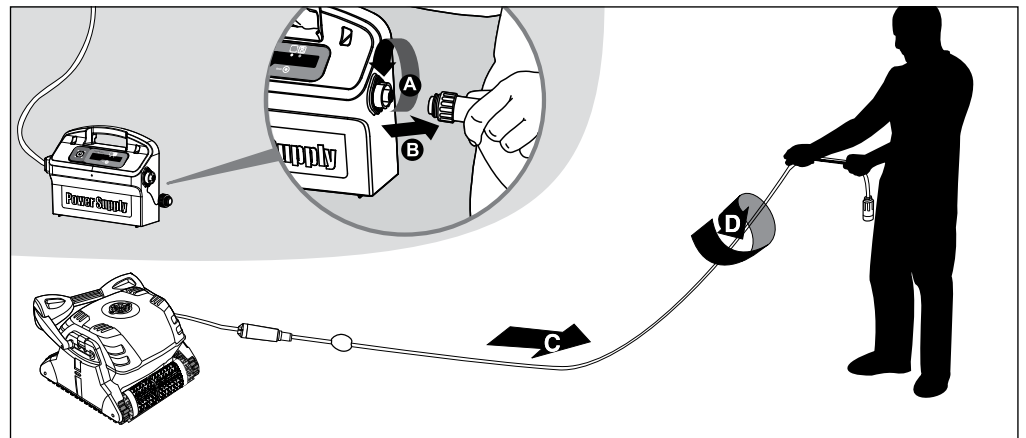

5.5. Off-season storage

If the pool cleaner will not be in use for an extended period, perform the following storage steps:

- Make sure that no water is left in the pool cleaner
- Thoroughly clean the filter bag and insert in place
- Roll up the cable so that it has no kinks and place on the Caddy
- Store the pool cleaner upright on the Caddy in a protected area out of direct sun/rain/frost at a temperature of between 5 °C – 45 °C (41 °F – 113 °F)

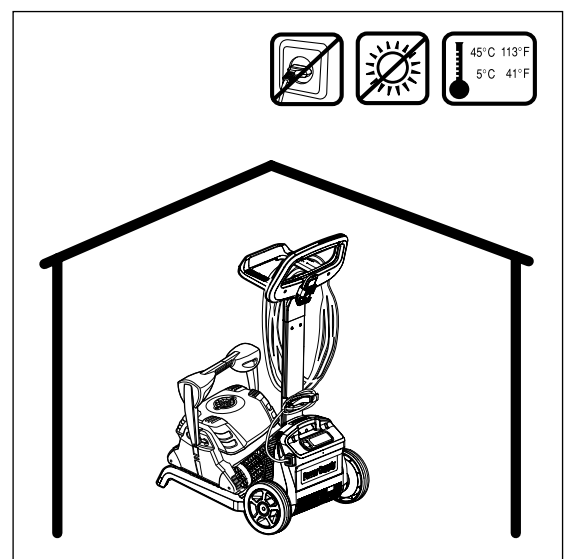

6. POWER SUPPLY

Digital "Switch-Mode" Power Supply with full filter bag and delay indicator.

- Input - 100 VAC – 250 VAC
- 50 Hz – 60 Hz
- 180 W
- Output - <30 VDC
- IP 54

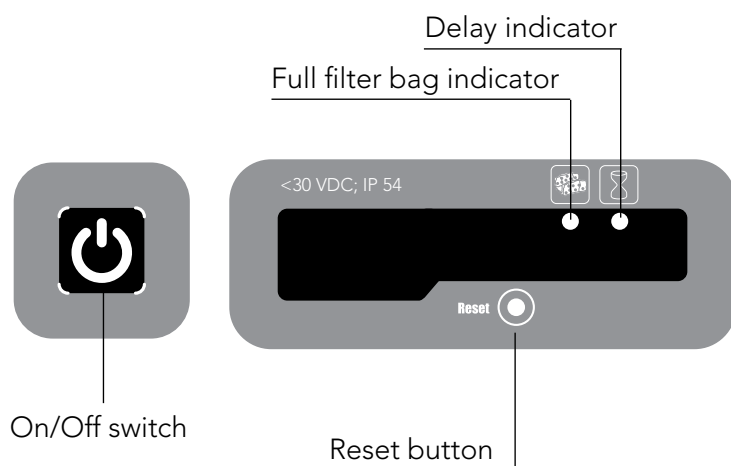
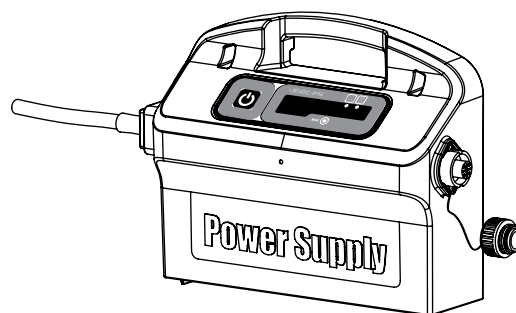

Full filter bag indicator and Reset button

The power supply is equipped with a filter bag status indicator.

The red LED indicates two filter conditions.

- When blinking - The filter is partially blocked.
- When lighted - The filter is blocked and must be emptied and cleaned.

If the LED does not turn off after the filter bag had been emptied and cleaned, press the RESET button while the robot is working.



Delay indicator

The power supply is equipped with a Delay indicator that indicates if the Delay option is activated (through the remote control unit).

7. REMOTE CONTROL UNIT

The Control Panel

The remote control unit (RCU) offers two operation modes – Automatic mode and manual direction control mode.

In automatic mode, the cleaning parameters can be changed.

In manual direction mode, the robot's motion can be controlled manually.

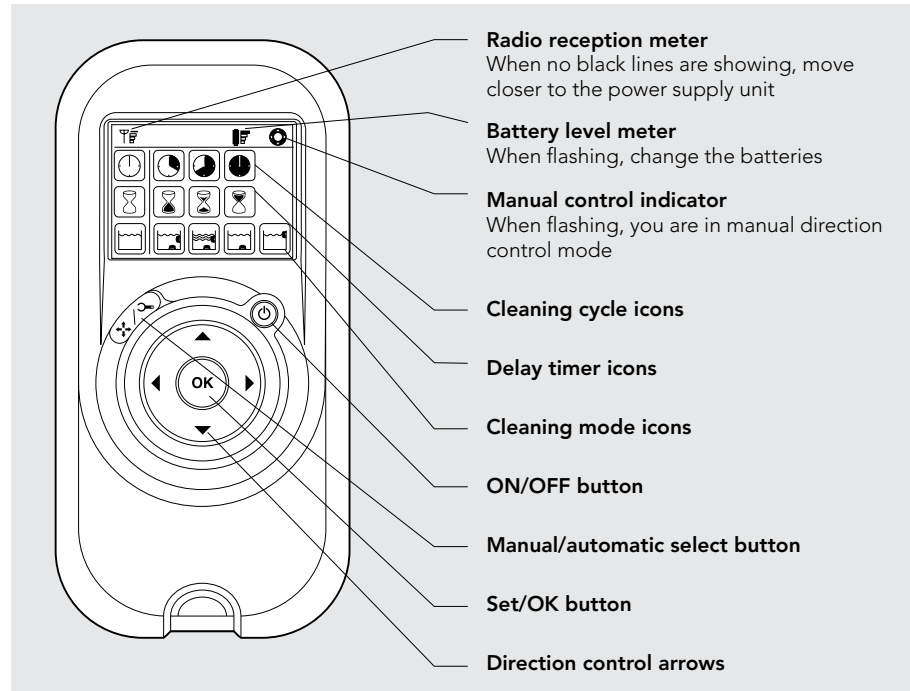

Manual Direction Control Mode

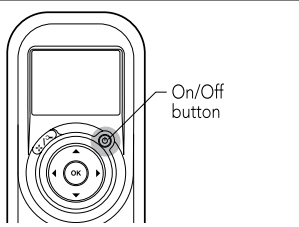

1. Press the On/Off button once. The remote control will start in manual direction control mode.
2. Use the direction control arrows (see right) to control the movement of the robot around the pool.

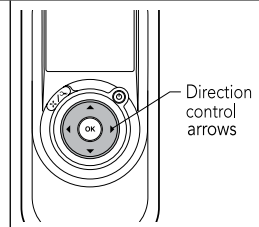

Exiting Manual Direction Control Mode and setting the Automatic Mode

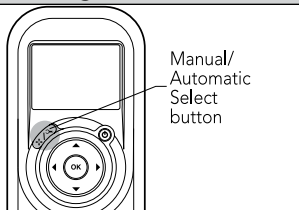



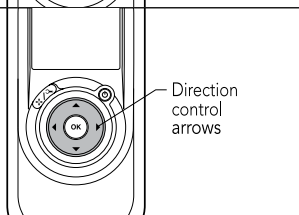
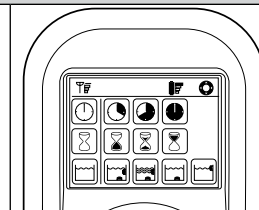



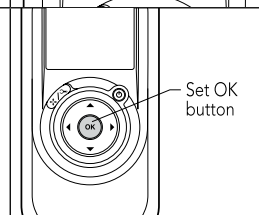





1. To exit the manual direction control mode, press the Manual/Automatic select button once only.
2. The digital screen will light up and three rows of function icons will be displayed in default mode.



1. To change the parameters press the up or down arrows.
2. To select the parameter settings use the right or left arrows. When you reach the required function press the Set/OK button.



Press the Manual/Automatic select button and then choose the desired parameters according to the following table:

 <p>Cleaning cycle indicator This determines the length of the cleaning cycle.</p>	 <p>Fast 4-hour cycle</p>	 <p>Efficient 6-hour cycle for everyday use. (Default setting)</p>	 <p>Extra 8-hour cycle</p>	
 <p>Delay time indicator This determines when the pool cleaner starts to work. Delaying allows the dirt to settle to the bottom of the pool.</p>	 <p>Immediate start (Default setting)</p>	 <p>One-hour delay</p>	 <p>Two-hour delay</p>	
 <p>Cleaning action indicator Allowing you to choose from the following options.</p>	 <p>Standard Floor and wall cleaning. (Default setting)</p>	 <p>Ultra-clean Stronger suction and slower movement. (floor and wall)</p>	 <p>Floor only Cleans only the floor and the area where the floor and walls meet</p>	 <p>Walls only Cleans walls and waterline only</p>

Note:



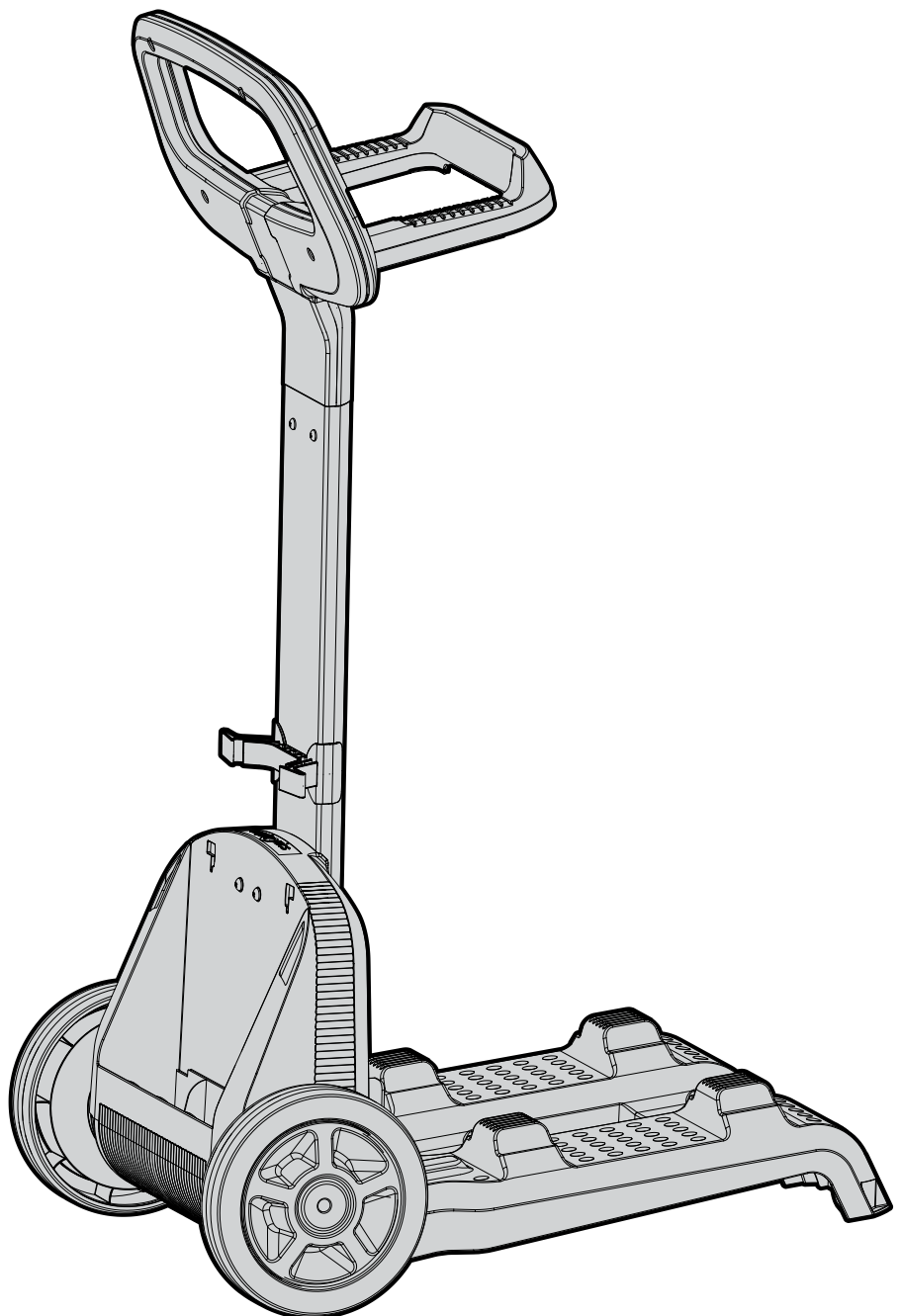

- After 2 minute if no button is pressed, the Remote Control Unit will shut-down and the Pool cleaner will continue to work in the previous settings.
- When the "Ultra-Clean" and "Walls Only" options finish their cycles, the Pool Cleaner will return to default settings.

Dolphin WAVE 100 Pool Cleaner

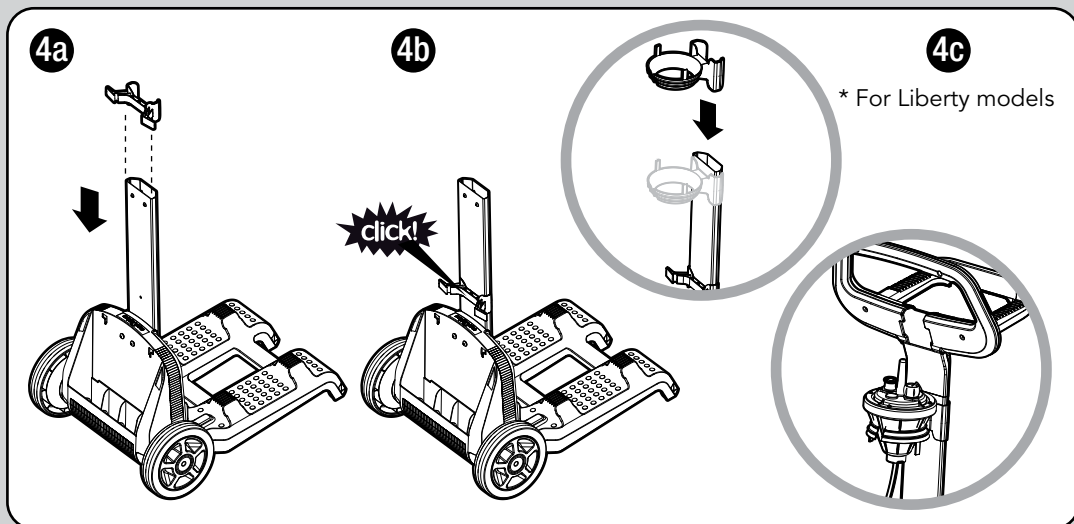
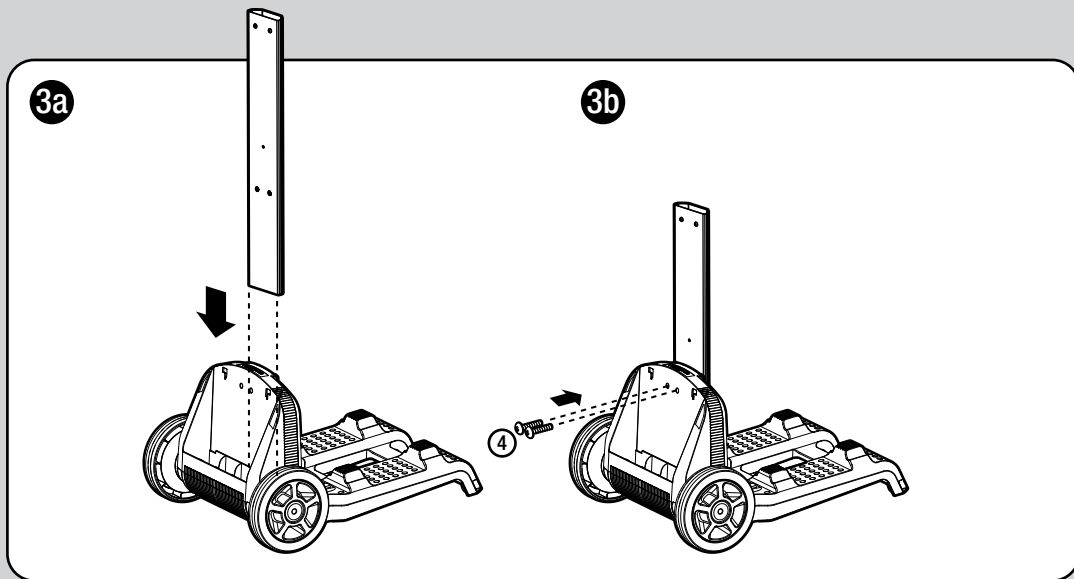
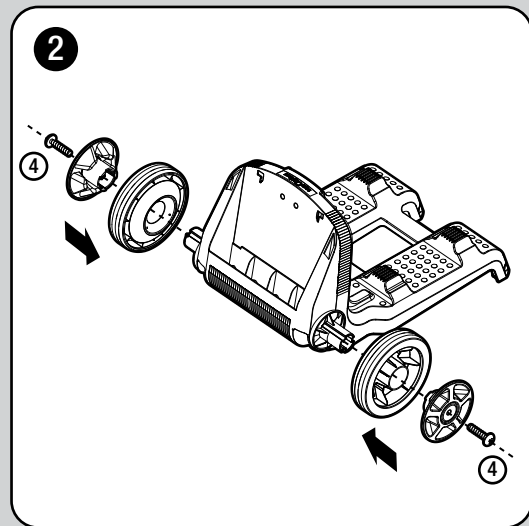
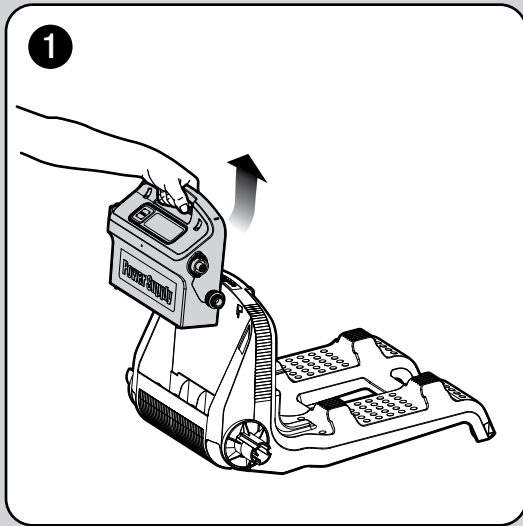
Caddy assembly





①	DIN 7985 A2 M5X35		x 2	③	DIN 1587 A2 M5		x 2
②	DIN 127B A2 M5		x 2	④	WN 1412 A2 KA50X16		x 6

