



Gaia Nova Epicea



Installation handbook



Manuel d'installation



Manual de instalación



Manuale di installazione



Installationshandbuch

Avertissements

Lisez attentivement ce manuel avant d'utiliser votre sauna pour la première fois.

Nous vous recommandons de le conserver précieusement pour de futures consultations.

- Le bois est un élément vivant, pour conserver son aspect initial, il est important de traiter l'extérieur du bois contre l'humidité. Utilisez un saturateur uniquement sur la partie extérieure du sauna.
- Installer le sauna sur un sol parfaitement plat et dur.
- Le sauna doit rester au sec. Ne pas l'utiliser près d'un point d'eau (baignoire, sol humide, piscine).
- Ne pas utiliser de produits nettoyants liquides. Débrancher le sauna avant de procéder au nettoyage et utiliser un chiffon humide. (voir chap. maintenance).
- Protéger le cordon électrique du sauna pour éviter qu'il soit piétiné ou pincé.
- Avant de procéder au remplacement de certaines pièces, assurez-vous qu'elles soient conçues par le fabricant ou qu'elles aient des caractéristiques semblables aux pièces d'origine. Un mauvais remplacement peut engendrer un incendie, un court-circuit ou une détérioration du sauna. Nous vous recommandons fortement de faire appel à un technicien qualifié.
- Pour éviter les risques de brûlures ou de décharges électriques, n'utilisez aucun outil métallique.
- Ne pas mettre d'animaux dans le sauna.
- Ne pas laisser le sauna allumé sans surveillance.
- Ne pas laisser le sauna allumé plus de 3 heures d'affilée sous peine de dégrader les équipements prématurément. Après 3 heures d'utilisation continue, éteignez le sauna pendant au moins une heure.
- Nous vous recommandons de ne pas installer de système de fermeture sur la porte du sauna.
- Vérifier la conformité de votre installation électrique avant de procéder au branchement électrique de votre sauna.

Notez et conservez les numéros de série du sauna ainsi que la facture d'achat.

Ils peuvent vous être demandés lors de votre demande de SAV.

Sécurité

ATTENTION :

Veillez lire attentivement les consignes de sécurité avant d'installer et d'utiliser votre cabine de sauna. Elles sont essentielles pour votre sécurité, veuillez les respecter rigoureusement.

Attention à l'hyperthermie, insolation et coup de chaleur qui peuvent être provoqués ou accentués par le non respect des consignes de sécurité. Les symptômes sont la fièvre, l'accélération du pouls, le vertige, l'évanouissement, la léthargie, l'engourdissement du corps ou d'une partie du corps.

Les effets : Ne plus percevoir la chaleur, ignorance du risque imminent, perte de conscience.

Ne doivent pas utiliser le sauna :

- Les enfants de moins de 6 ans.
- Les personnes ayant des réactions importantes aux rayons du soleil.
- Les personnes âgées ou invalides.
- Les personnes ayant des antécédents médicaux tels que les maladies cardiaques, hypertension / hypotension, problème de circulation sanguine ou diabète sans un avis médical préalable.
- Les femmes enceintes. Une température excessive peut être dangereuse pour le fœtus.
- Les personnes souffrant de déshydratation, plaies ouvertes, maladies des yeux, brûlures, coup de soleil.

Les enfants entre 6 et 16 ans peuvent utiliser le sauna à condition qu'ils soient sous la surveillance constante d'un adulte responsable et que la température ne dépasse pas 60°C (140°F).

En cas de problèmes de santé, de prise de médicament, de blessure musculaire ou ligamentaire, ne pas utiliser le sauna sans consultation et accord préalable d'un médecin.

En cas de port d'implants chirurgicaux ne pas utiliser le sauna sans consultation et accord préalable du chirurgien.

Ne pas utiliser le sauna après un effort intense. Attendez 30 minutes que votre corps refroidisse.

Ne pas faire de séance de sauna de plus de 40 minutes.

Ne pas consommer d'alcool ou de drogue avant ou pendant la séance.

Ne pas dormir dans le sauna lorsque celui-ci est en fonctionnement.

Afin d'éviter les risques de surchauffe, branchez votre sauna sur une prise de courant suffisamment puissante et ne raccordez pas d'autres appareils électriques sur la même prise murale.

Pour éviter tout risque d'électrocution ou de détérioration du sauna, ne pas utiliser le sauna :

- En cas d'orage.
- Si le cordon électrique est endommagé, il devra être remplacé par une personne qualifiée.
- Si le cordon électrique est en surchauffe, il devra être vérifié par une personne qualifiée.
- Si vous devez changer une ampoule, attendre que le sauna soit éteint et qu'il refroidisse.

Séchez-vous les mains avant de brancher ou débrancher le courant. N'agissez jamais avec les mains ou les pieds mouillés.

Ne pas allumer et éteindre frénétiquement le courant ou le système de chauffage car cela pourrait causer des dégâts au système électrique.

Ne pas essayer de réparer le sauna par vous-même sans l'accord du distributeur ou du fabricant du sauna. Les tentatives de réparations non autorisées annuleront la garantie du fabricant.

Ne pas utiliser n'importe quel type de détergent à l'intérieur du sauna.

Ne pas empiler ou stocker d'objets à l'intérieur ou sur le sauna.

Ne pas entreposer de matières inflammables ou d'agents chimiques près du sauna.



Description du sauna

Caractéristique technique

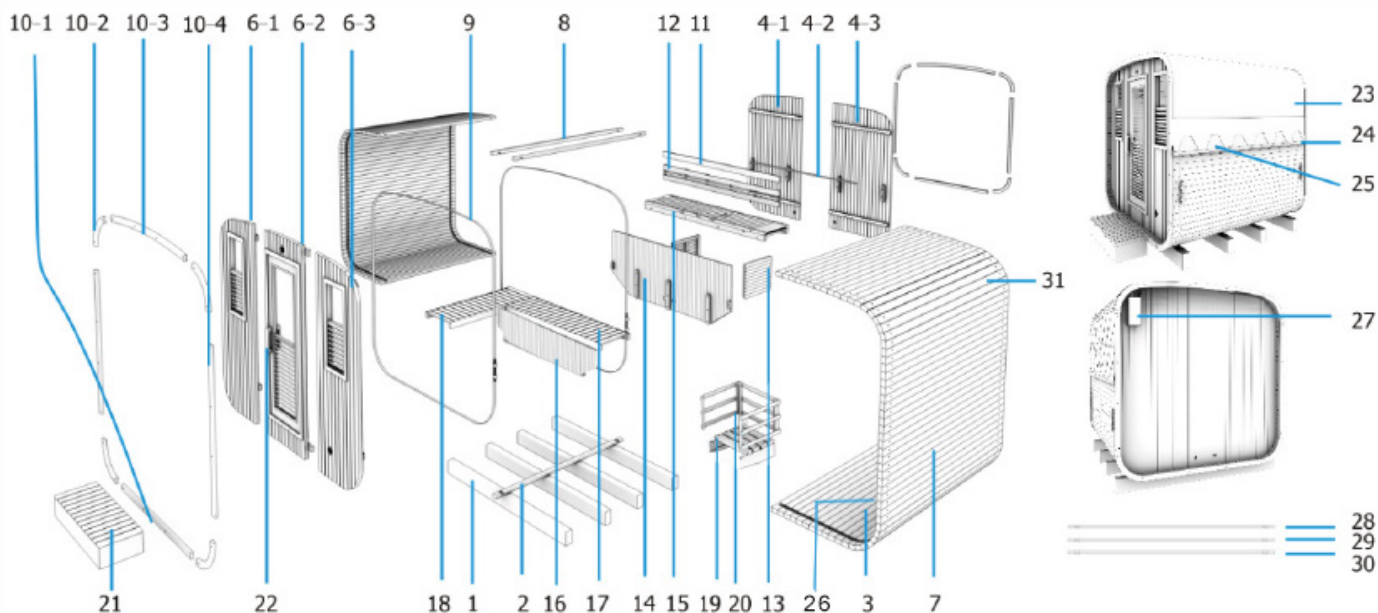
Modèle	HL-B200E
Bois	Epicéa canadien
Voltage	230 V - 50 Hz (hors poêle)

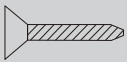

N°	Quantité	Name
1	4	Support sauna 1980x70x150
2	1	Latte inférieure spéciale (convexe des deux côtés)
3	16	lattes latérales spéciale sans trou
3-2	1	lattes latérales spéciale avec trous
4-1	1	Section de paroi arrière (gauche)
4-2	1	Barre de connexion murale arrière
4-3	1	Section de paroi arrière (droite)
6-1	1	Section de paroi avant (fenêtre de gauche)
6-2	1	Section de paroi avant (porte vitrée)
6-3	1	Section de paroi avant (fenêtre de droite)
7	52	Lattes de sauna standard 1998x85x38mm
8	2	Latte supérieure spéciale 76 x 38mm (convexe d'un côté)
9	2	Bandes de sauna en acier inoxydable
10-1	2	Avant-toit décoratif (inférieur)
10-2	4	Avant-toit décoratif (coin)
10-3	2	Avant-toit décoratif (supérieur)
10-4	4	Avant-toit décoratif (côté)
11	1	Ruban LED
12	1	Dossier
13	2	Panneau de banc supérieur (côté)
14	1	Panneau supérieur de banc (avant)

	Dimensions	QTY
	Ø 5 x 50	32
	Ø 4 x 40	188
	Ø 4 x 25	8
	Ø 3 x 18	6
	Ø 3 x 16	250
	Ø 6 x 75	2
	Ø 4 x 12	4
	Clé Allen 1	1
	Clé Allen 2	1

Installation

15	1	Panneau de banc supérieur (pliable)
16	1	Support de banc
17	1	Banc bas
18	1	Banc latéral
19	1	Support de poêle pour sauna (avec bac à eau)
20	1	Protection du poêle (trois pièces par jeu)
21	1	marche d'entrée
22	1	Poignée de porte
23	1	Shingle (gris)
24	2	Nez d'eau
25	77	Bardeau d'asphalte (gris)
26	1	Cache Cable
27	1	Boîtier de commande
28	1	Latte de remplissage supérieure (10 mm)
29	1	Latte de remplissage supérieure (15 mm)
30	1	Latte de remplissage supérieure (20 mm)
31	16	Latte spéciale d'angle (70x38mm) avec trou
31-2	16	Latte spéciale d'angle (70x38mm) sans trou

Lisez attentivement les instructions de montage avant de commencer l'assemblage.

Choix de l'emplacement

Les saunas Holl's sont uniquement prévus pour une installation en extérieur.

Choisissez un espace :

- Au sec, sur un sol plat et stable, pouvant supporter le poids de votre sauna.
- La hauteur doit être suffisante pour vous permettre d'accéder au toit et de réaliser les branchements électriques et la maintenance.
- Éloigné de toute source d'eau, de flamme ou de substances inflammables.

Une dalle béton, parfaitement plate, de niveau, et sèche est nécessaire pour accueillir le sauna extérieur, sans quoi le montage correct pourrait en être compromis.

Conseils pratiques

- Notez que le montage du sauna requiert deux à trois adultes.
- Identifiez clairement chaque panneau avant de commencer.
- Pendant le montage, placez le cordon d'alimentation de votre sauna de sorte qu'il soit facilement accessible.
- Notez que des variations existent selon les modèles.

ATTENTION:

Vérifier les trous et leurs diamètres pour éviter d'endommager le bois.
La hauteur minimale requise pour l'installation est de 2020 mm.

Outils nécessaires

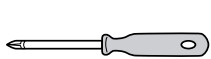

Tournevis
cruciforme



Mètre



Escabeau



Crayon



Cutter



2 Clé plates

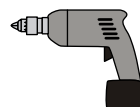

Visseuse
électrique

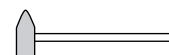

Maillet



Foret à bois



Clé allen

Assemblage

Étapes de l'assemblage du sauna

étape 1:

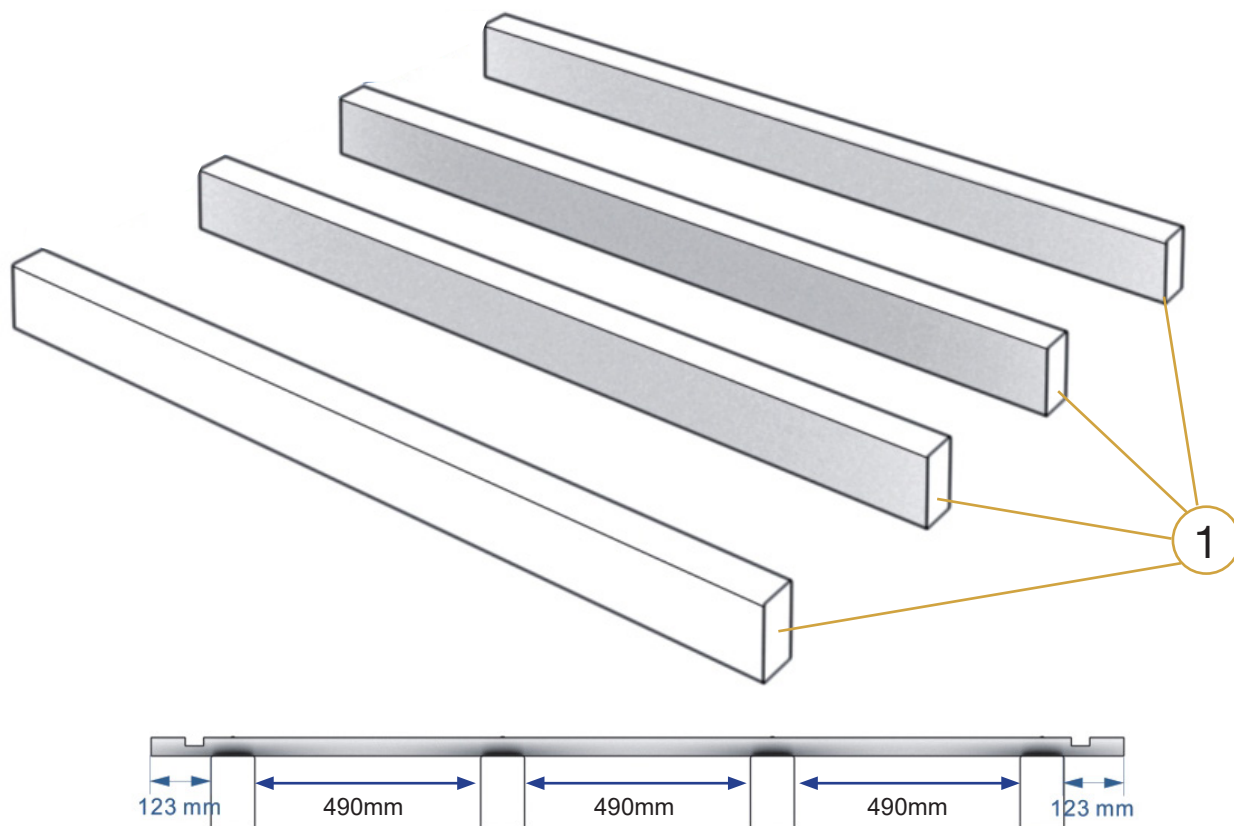

Étape 2:

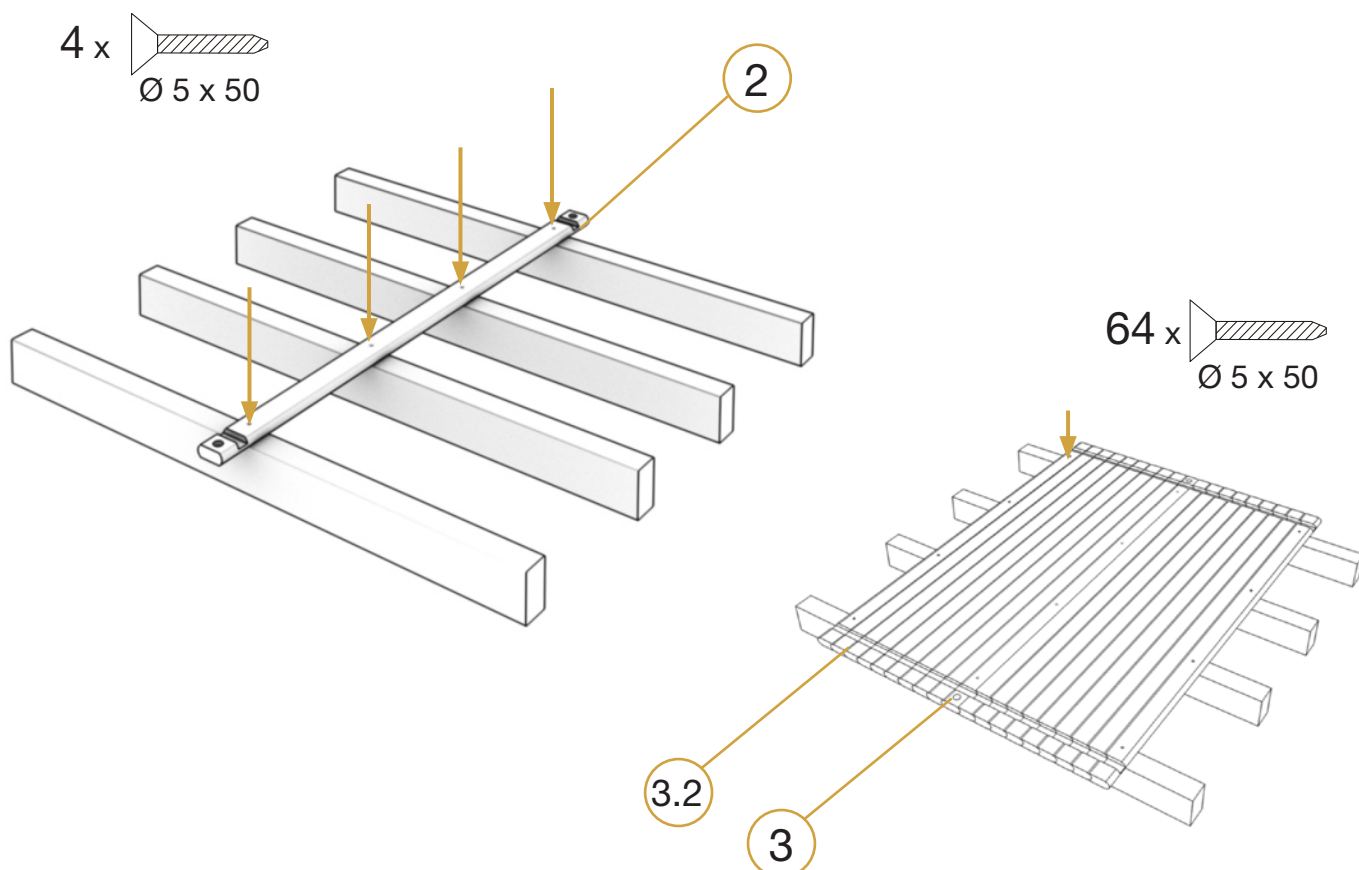

FR

Assemblage

Étape 3:

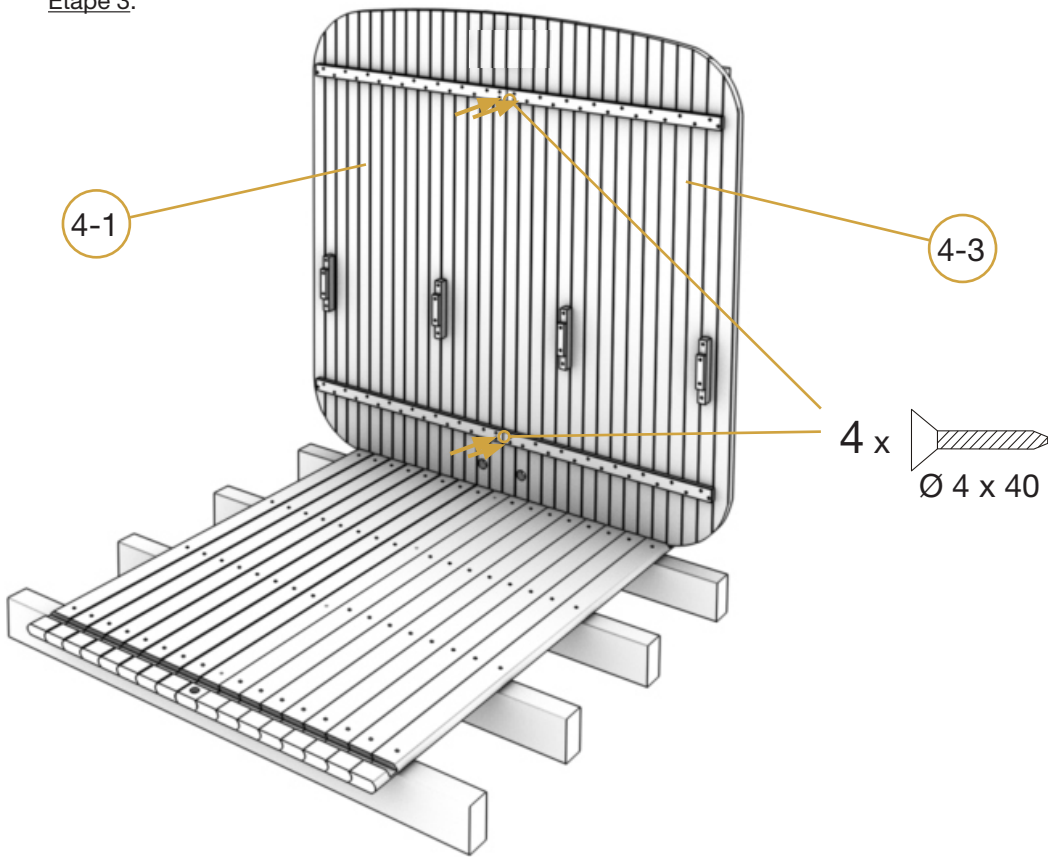

Étape 4:

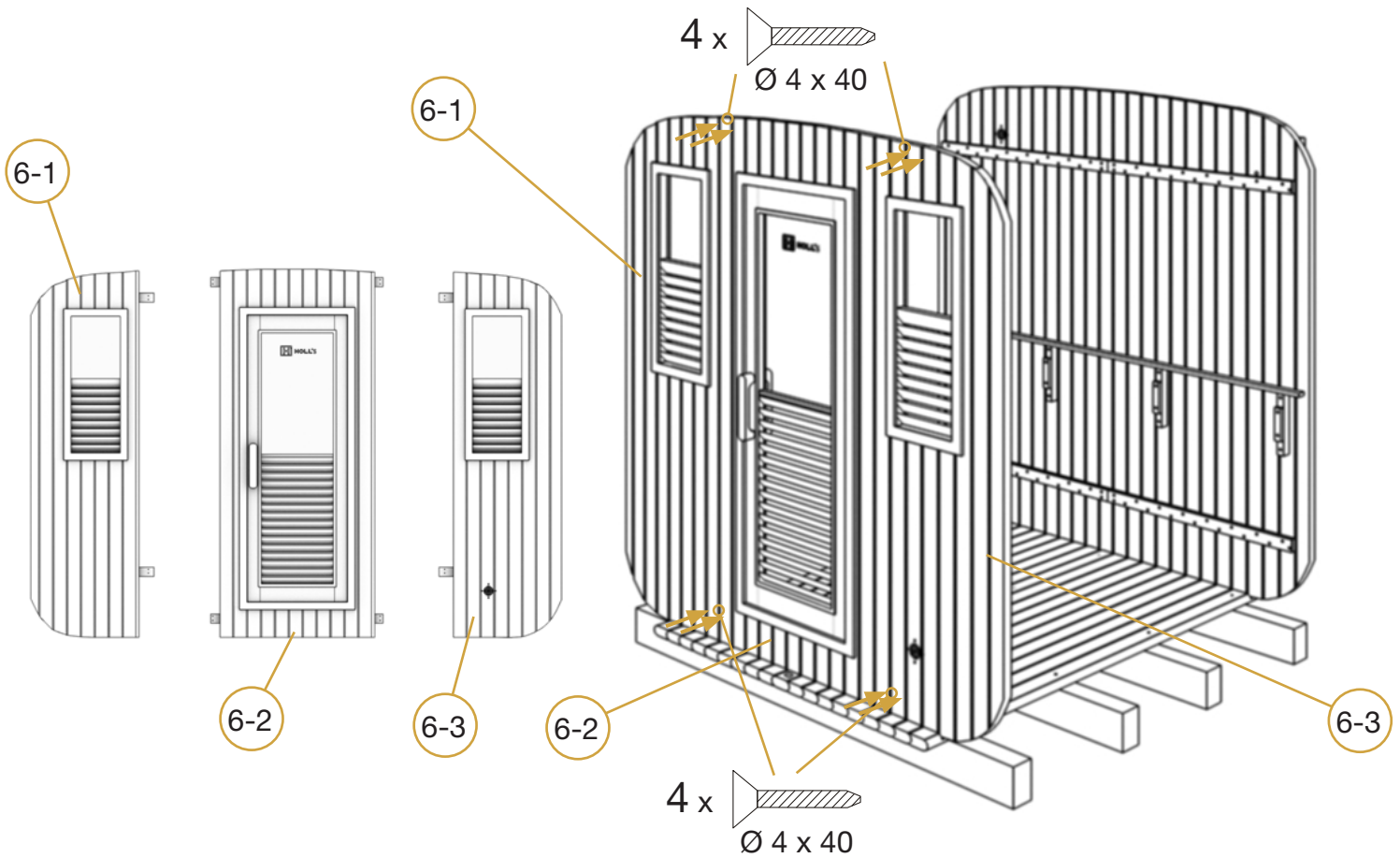

Assemblage

Étape 5:

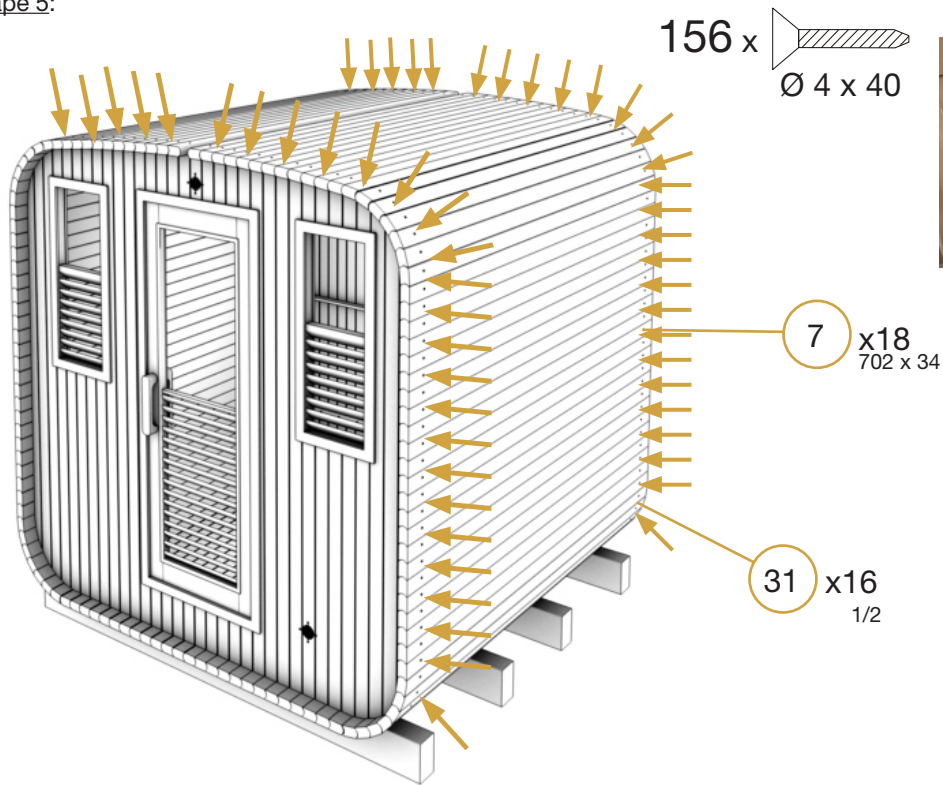

FR

Étape 6:

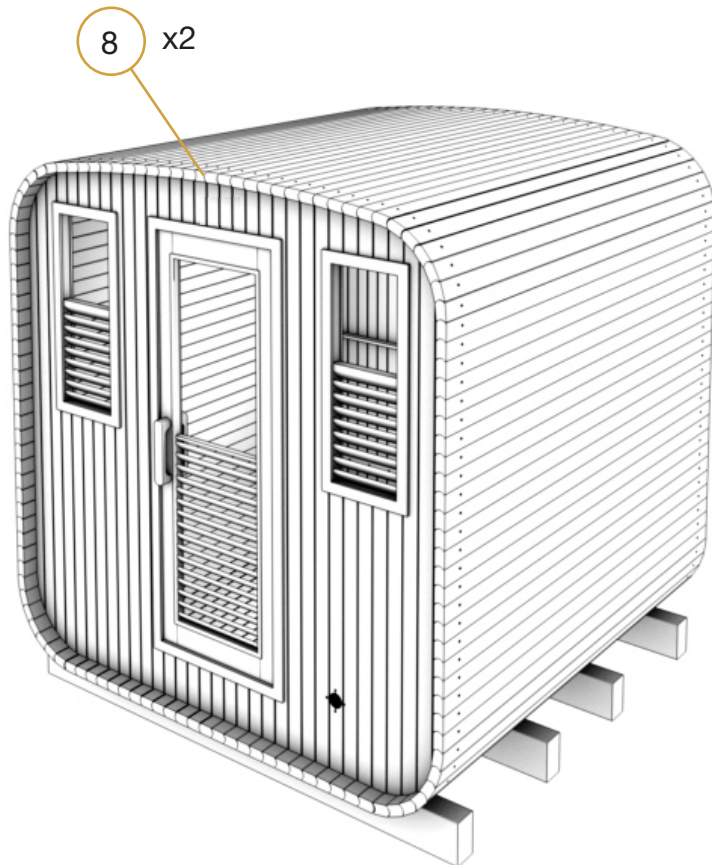

28 / 29 / 30

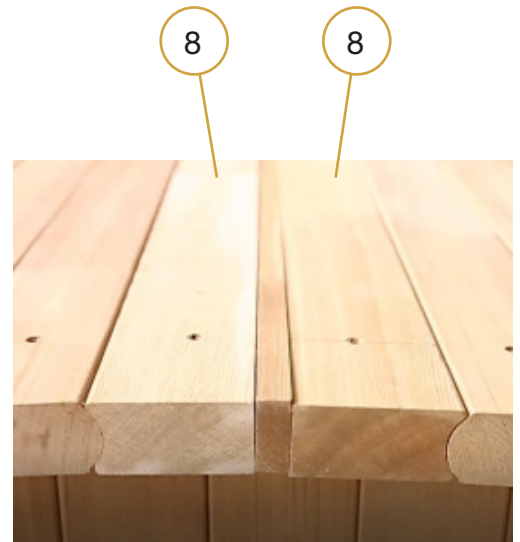

Assemblage

Étape 7:

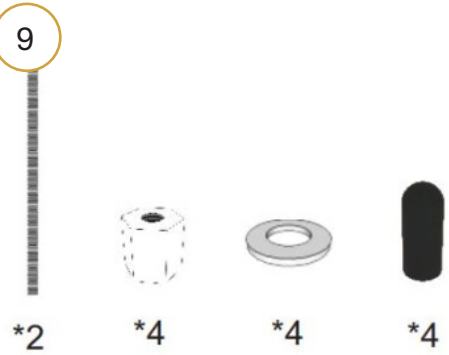
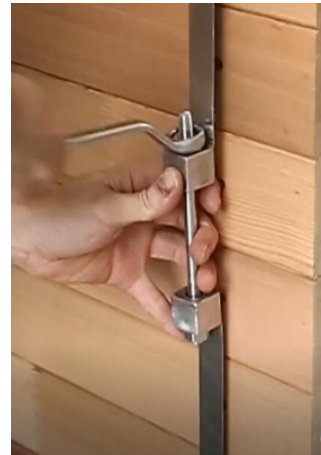
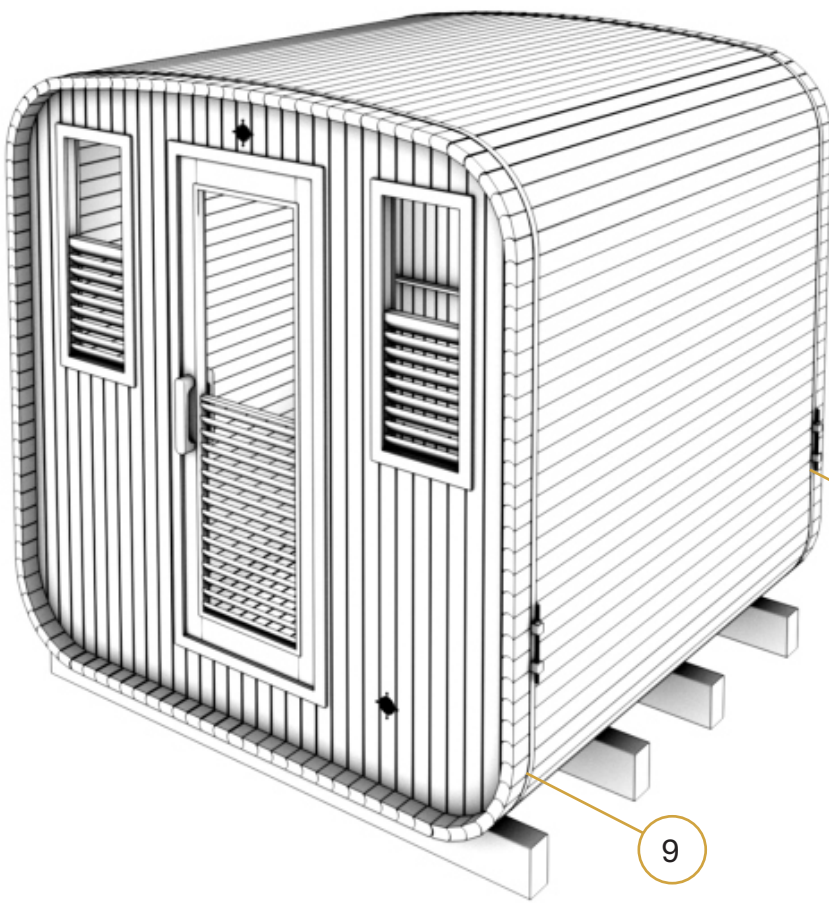

Étape 8:

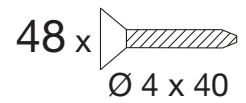
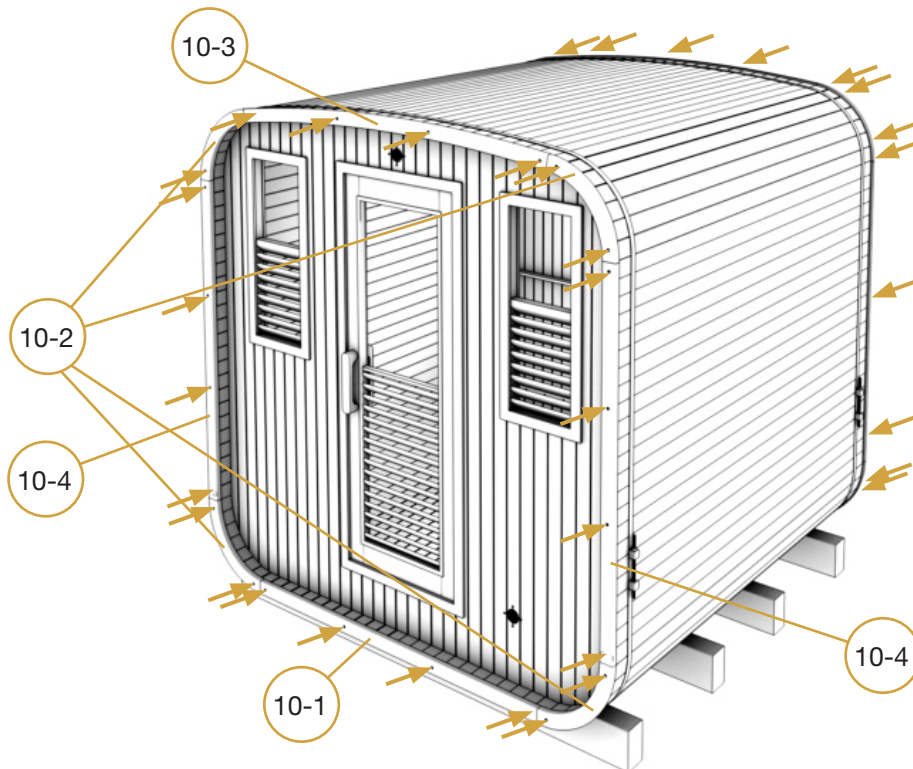

Assemblage

Étape 9:

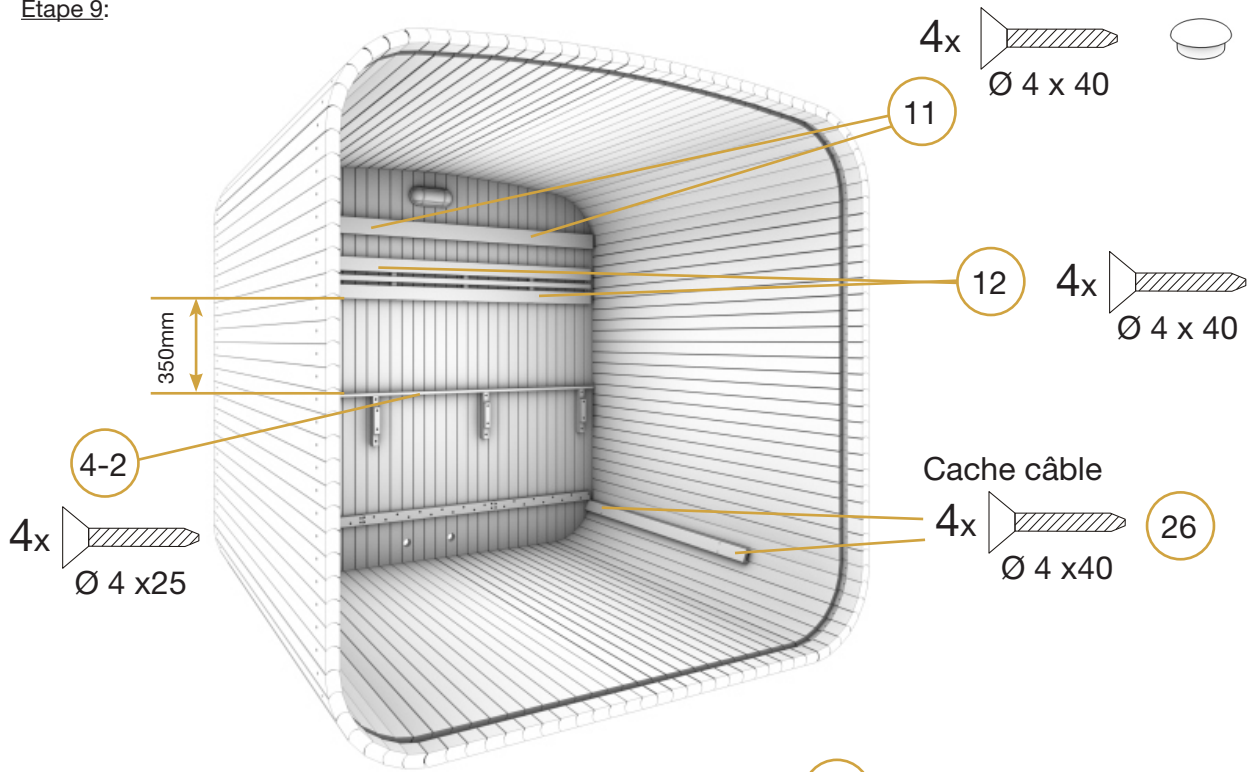

Étape 10:

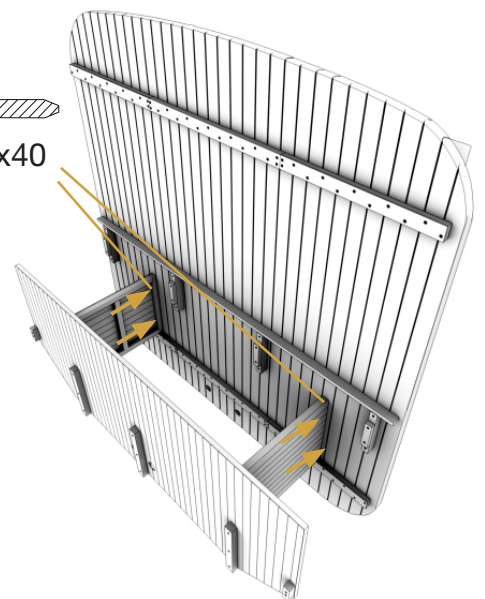
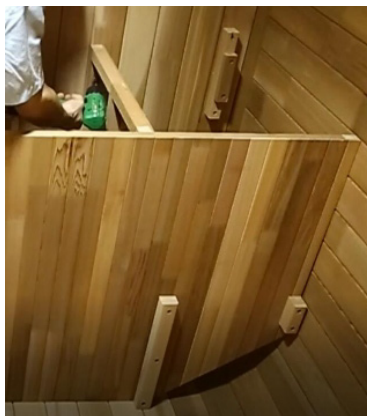
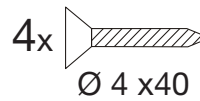
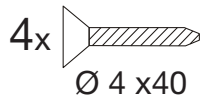
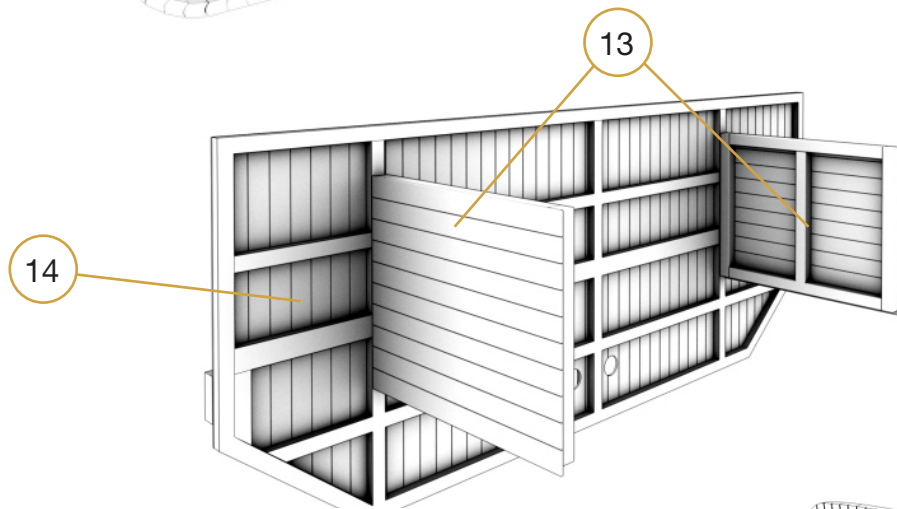

FR

Assemblage

Étape 11:

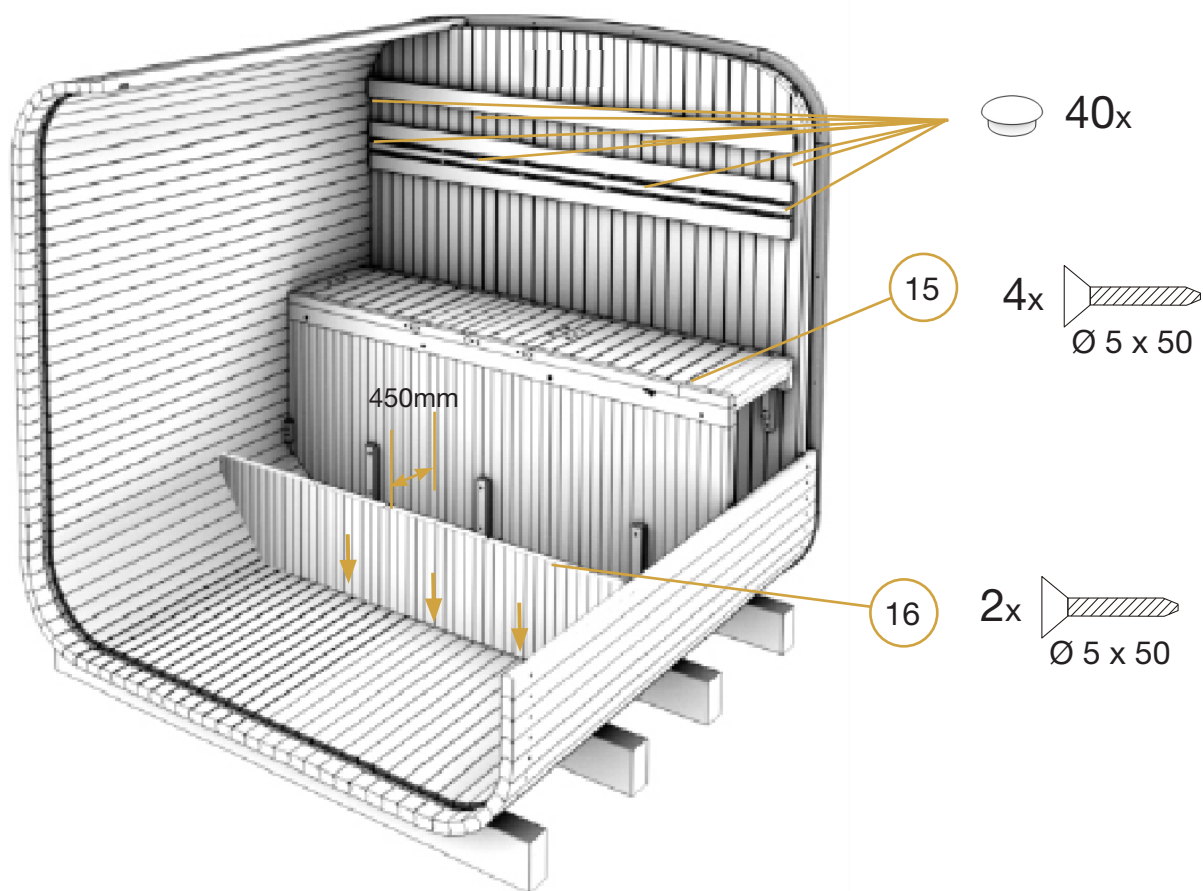

Étape 12:

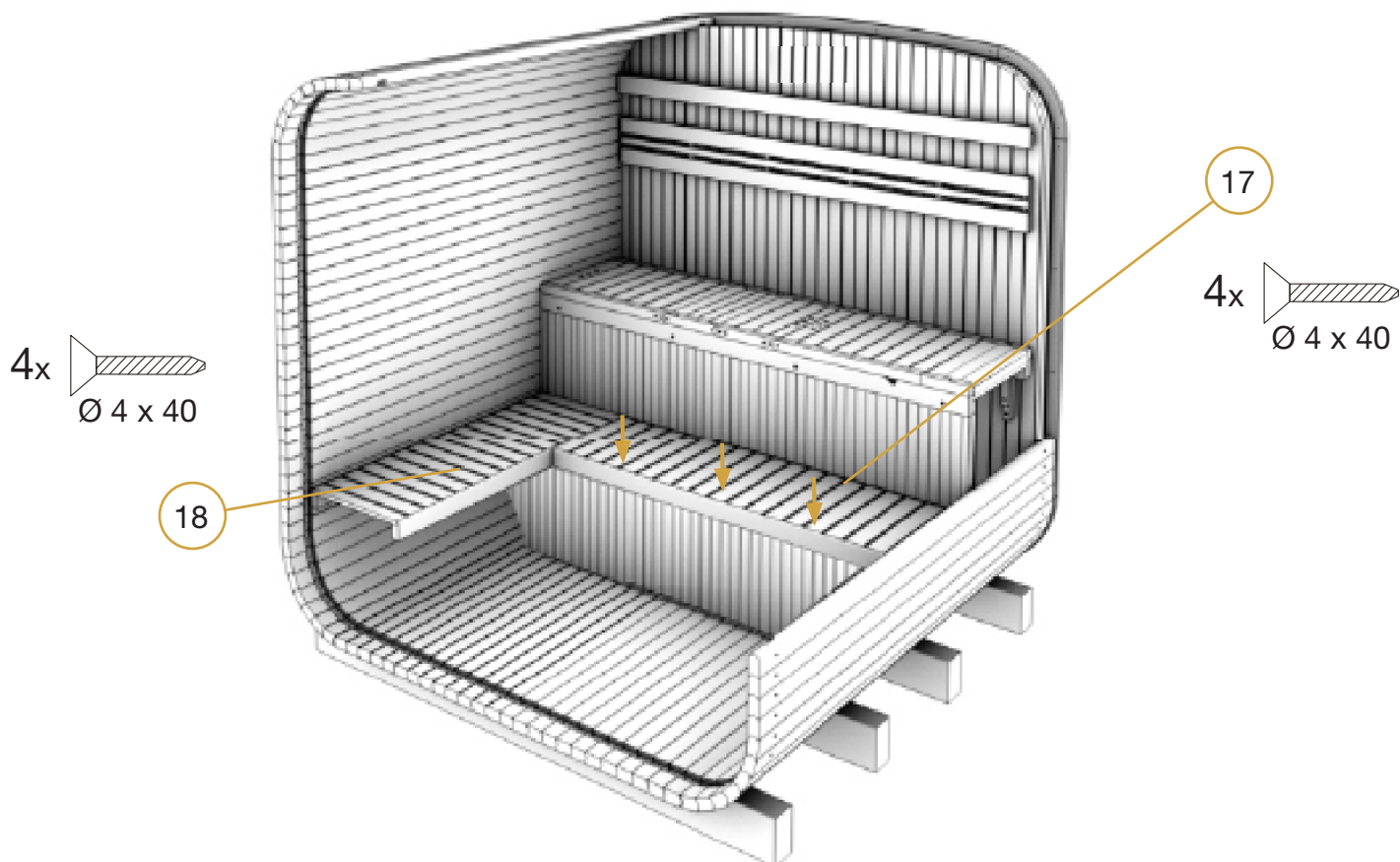

Assemblage

Étape 13:

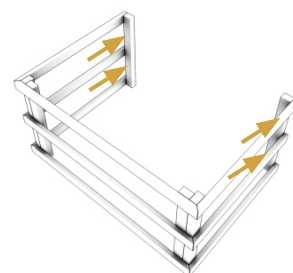
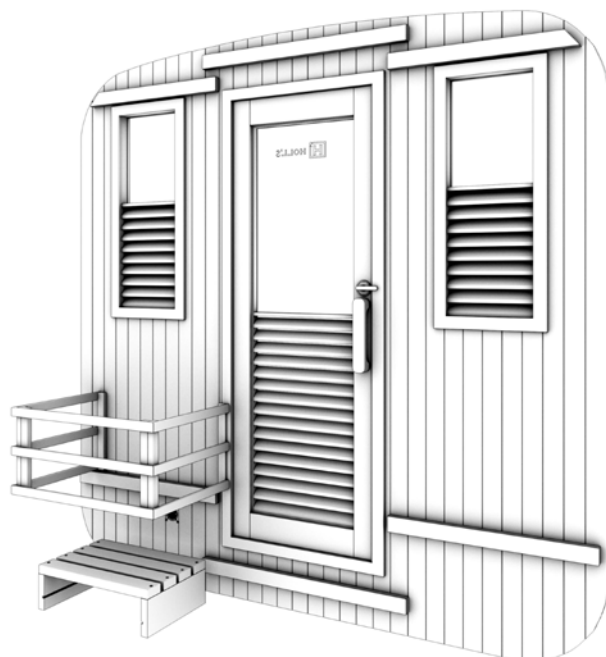

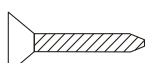
2x 
Ø 5 x 50

19

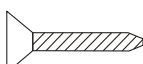
8x 
Ø 4 x 40

20



Étape 14:

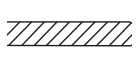

2x 
Ø 6 x 70

21

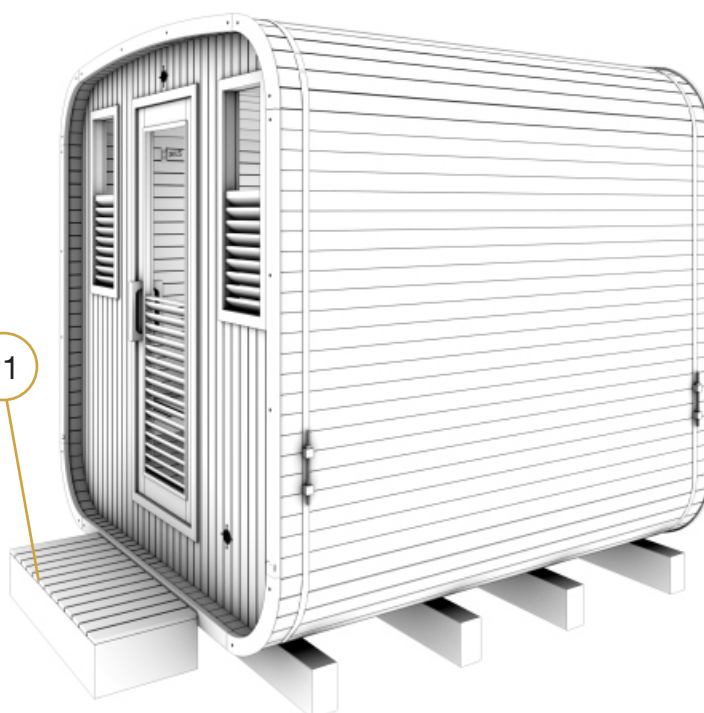

FR

Assemblage

IMPORTANT :

La couverture de toit est indispensable pour assurer l'étanchéité du sauna, il faut l'adapter selon l'environnement.

Étape 15:

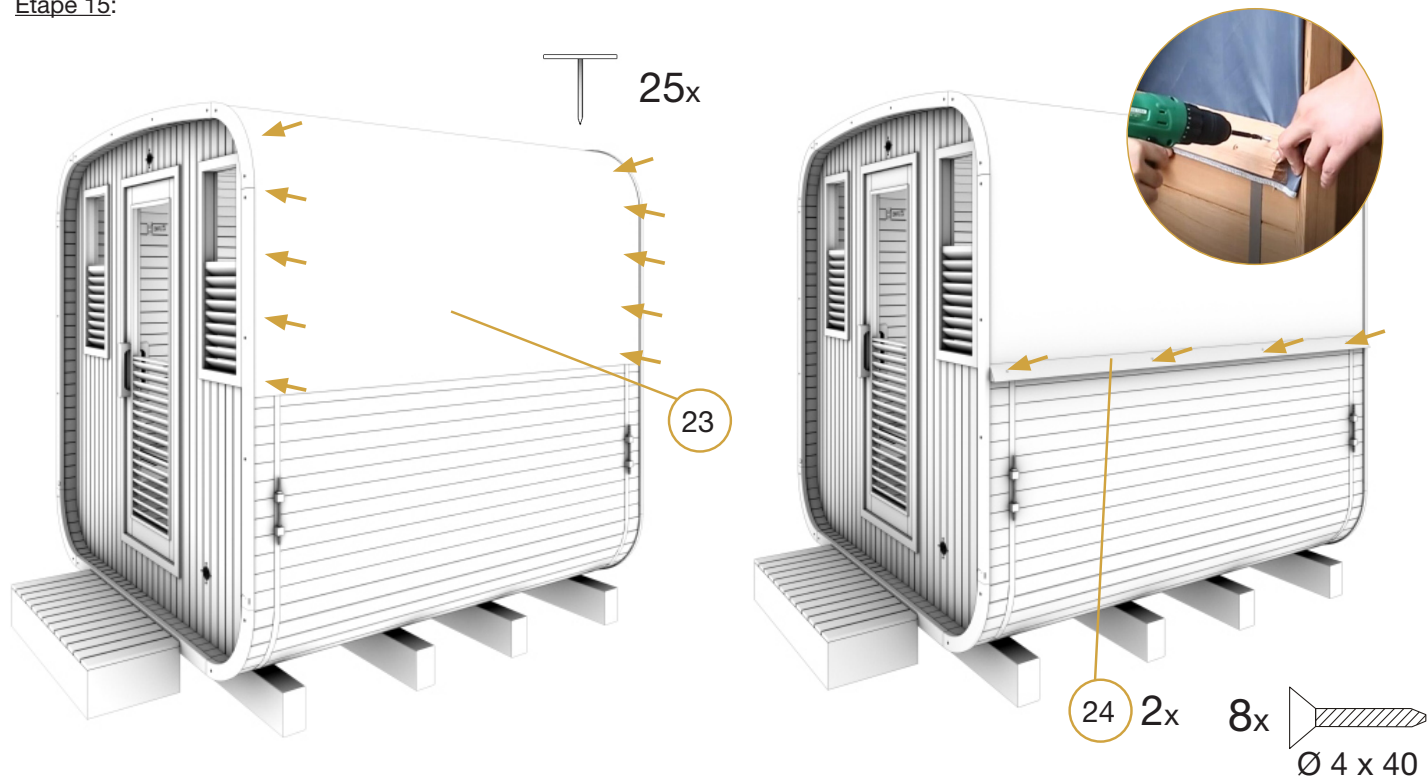

Étape 16:

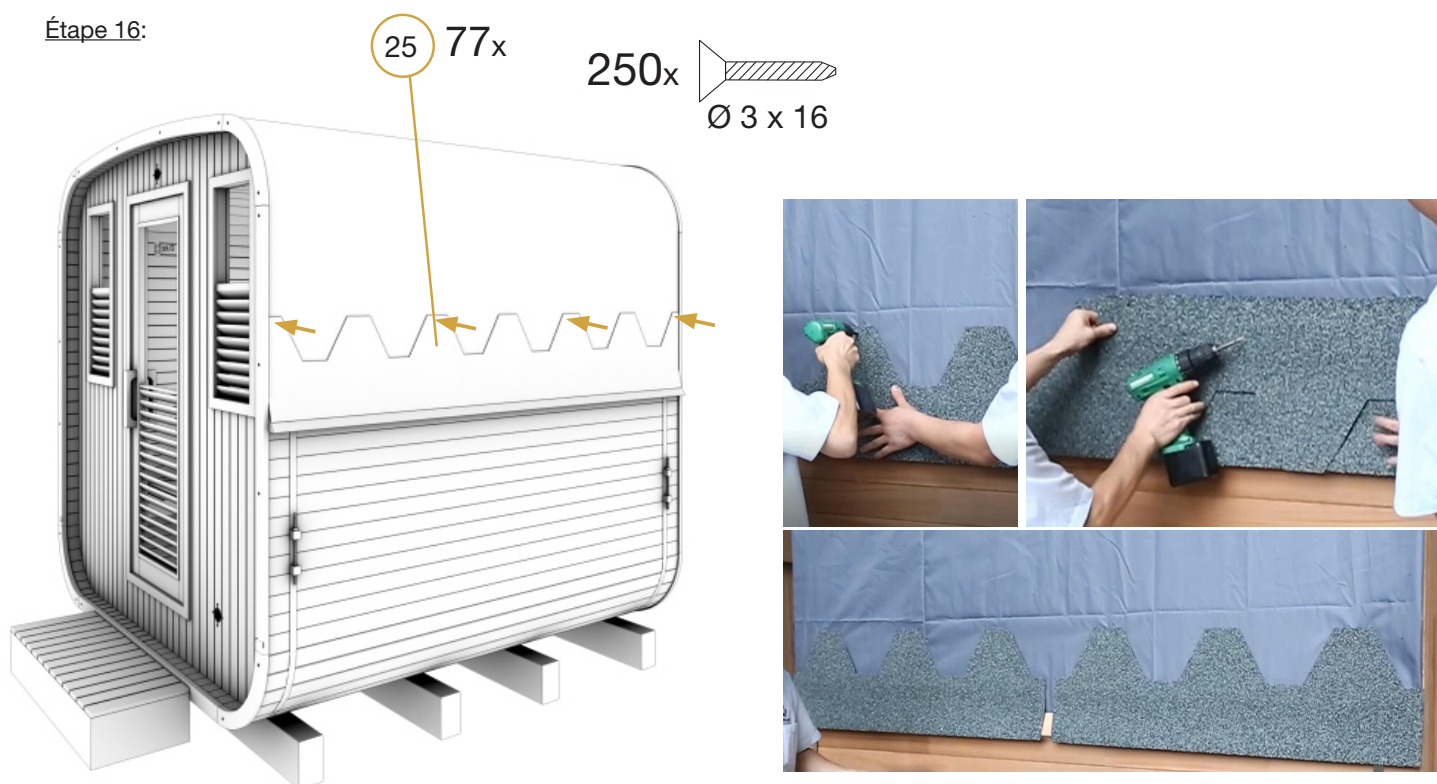

Assemblage

Étape 17:

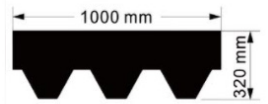
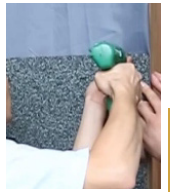
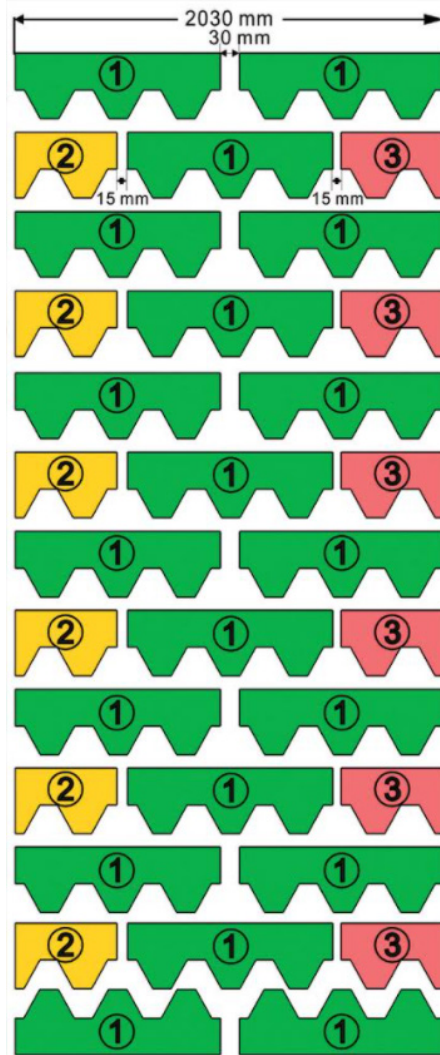
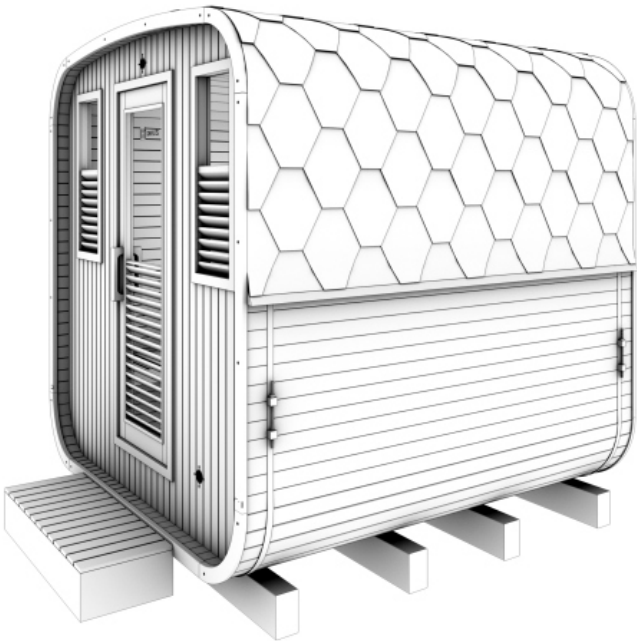

① 1000*320=49

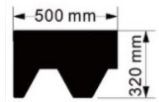

② 500*320=14

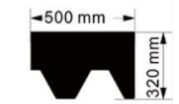

③ 500*320=14

Étape 18:

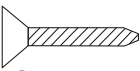
4x  Ø 4 x 25

27



1: connect

2: fix

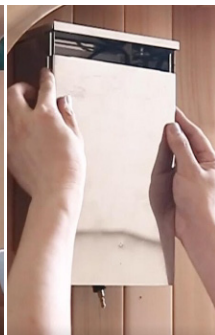
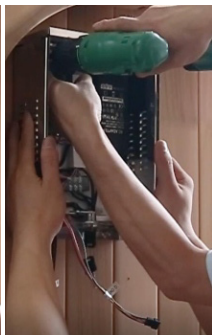

FR

Maintenance & entretien

Maintenance

IMPORTANT:

Débranchez le câble d'alimentation de la cabine avant toute intervention.

Problèmes constatés	Raisons possibles	Solutions
Le poêle électrique ne chauffe pas.	Le cordon d'alimentation est débranché.	Vérifiez le branchement du cordon d'alimentation.
	L'alimentation générale est coupée.	Vérifiez le bon fonctionnement du tableau électrique et de la prise murale.
	Le poêle est en sécurité-surchauffe.	Référez vous au manuel du poêle électrique.
Le luminaire du sauna ne fonctionnent plus.	Le câble de la lampe n'est pas bien branché.	Brancher le câble.
	La lampe est défectueuse.	Contactez votre revendeur.

Entretien

1. Débrancher votre sauna.
2. Utilisez un aspirateur pour retirer toutes les poussières des interstices du bois.
3. Nettoyez la cabine avec une serviette en coton humide, si nécessaire utilisez une petite quantité de savon. Rincez en utilisant une serviette humide.
4. Nettoyez le verre avec un nettoyant pour vitre et un chiffon doux.
5. Entretien l'extérieur du sauna tous les 2 ans avec un produit adapté.
6. En cas de forte pluie, des oréoles peuvent apparaître à l'intérieur du sauna, il ne s'agit pas d'un défaut d'étanchéité par capillarité

ATTENTION:

Le bois doit être traité avec un produit protecteur uniquement sur l'extérieur du sauna.

Aucun traitement ne doit être appliqué à l'intérieur du sauna.

N'utilisez pas de benzène, d'alcool, de produits chimiques ou de nettoyants forts sur le sauna car les produits chimiques peuvent endommager le bois. Ne pas pulvériser d'eau sur votre sauna.

Garantie

L'ensemble des éléments composant le sauna sont garantis 2 ans et 4 ans pour les pièces de bois.

La date d'entrée en vigueur de la garantie est la date d'expédition (correspondant à la date d'édition de la facture).

La garantie ne s'applique pas dans les cas suivants :

- Dysfonctionnement ou dommage résultant d'une installation, d'une utilisation ou d'une réparation non conforme aux consignes de sécurité.
- Dysfonctionnement ou dommage résultant de conditions impropres à l'usage initialement prévu de l'appareil.
- Dommage résultant d'une négligence, d'un accident ou d'un cas de force majeure (orage et intempérie).
- Dysfonctionnement ou dommage résultant de l'utilisation d'accessoires non autorisés.
- Dysfonctionnement ou dommage résultant de la non installation d'un toit étanche.
- Dysfonctionnement ou dommage résultant du non entretien de l'extérieur du sauna.

La garantie ne prend pas en charge les frais liés à un rapatriement de la cabine ou d'une partie de ses composants dans nos ateliers. Dans le cadre de la garantie, en cas de panne, les pièces jugées défectueuses par nos techniciens seront échangées. Les informations et explications nécessaires à leur installation seront fournies par l'un de nos techniciens. Les frais liés à l'emploi d'une main d'œuvre tierce ne pourront être pris en charge par Holl's.



IMPORTANT

Ne retournez pas le produit au magasin

Contactez votre centre de service après-vente local sur www.holls.fr ou **POOLSTAR**
960 Avenue Olivier Perroy, 13790 ROUSSET - FRANCE

Commande LED

	boitier de commande LED	Télécommande
Température de fonctionnement	-30°C / 60°C	-30°C / 60°C
Alimentation	CD5V / 12/24V DC	2 piles NO7 - 3V
Sortie	3 channels N-MOS drain open output	-
Consommation électrique	0.5W	0.09mW
Sortie	6A 3 canaux : 18A 6A	
Dimensions du boitier	83 x 79 x 33cm	

Fonctions :

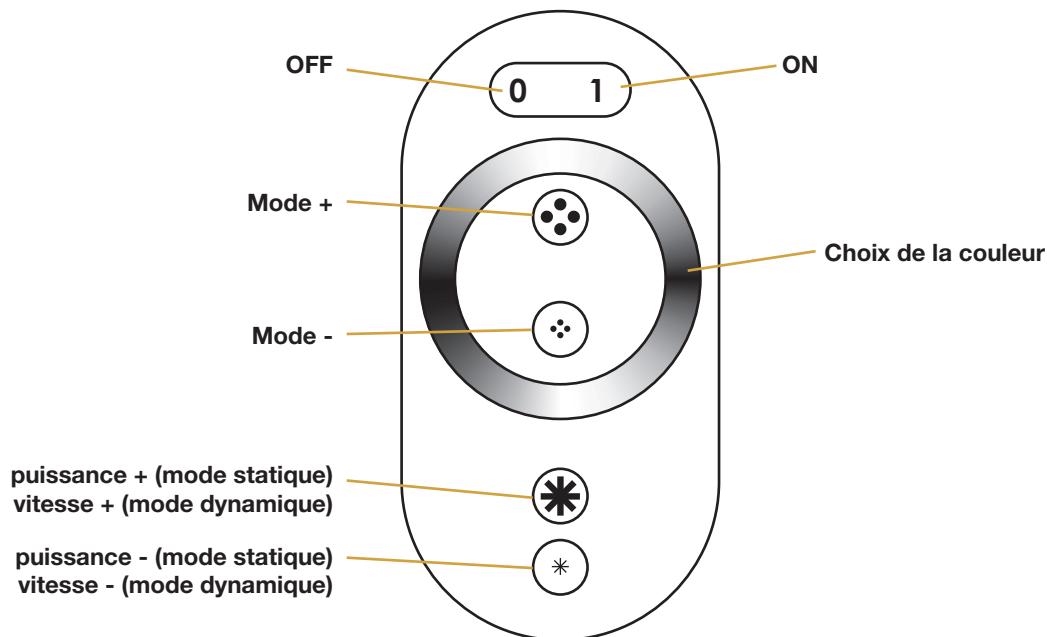

FR

Mode	éclairage	commentaire		
1	statique rouge (R)	Luminosité ajustable	10	transition 3 couleurs (G/B/R)
2	statique vert (G)		11	transition 5 couleurs (G/B/P/R/Y)
3	statique bleu (B)		12	transition 7 couleurs (G/B/Y/P/LB/W/R)
4	statique jaune (Y)		13	Vague 5 couleurs (R/Y/G/B/W)
5	statique violet (P)		14	flash 3 couleurs (R/G/B)
6	static bleu clair (LB)		15	Flash 7 couleurs (W/R/G/B/Y/P/LB)
7	statique blanc (W)		16	Flash dynamique 3 couleurs (R/G/B)
8	Saut entre 3 couleurs (G/B/R)	Vitesse et luminosité ajustables	17	Flash dynamique 7 couleurs (R/G/B/Y/P/LB/W)
9	Saut entre 7 couleurs (R/G/B/Y/P/LB/W)		18	Automatique

Recommendations

EN

Read this manual carefully before using your sauna for the first time.

We recommend you keep it in a safe place for future reference.

- Wood is a living element, to maintain its original appearance, it is important to treat the outside of the wood against moisture. Use a saturator only on the outside of the sauna.
- Install the sauna on a perfectly flat and hard surface.
- The sauna must remain in a dry area. Do not use it near a source of water (bath, damp floor, swimming pool).
- Do not use liquid cleaning products. Disconnect the sauna before cleaning and use a wet rag (see Maintenance section).
- Protect the sauna's electrical cable to avoid it being crushed or pinched.
- Prior to replacing certain components, ensure that they are specified by the manufacturer or that they have the same features as the original parts. Incorrect replacement can cause a fire, a short circuit or damage to the sauna. We strongly recommend using a qualified technician.
- To avoid the risk of burns or electric shocks, do not use any metal tools.
- Do not put animals in the sauna.
- Do not leave the sauna switched on without supervision.
- Do not leave the sauna switched on for more than 3 hours at a time to avoid premature deterioration of the equipment. After 3 hours continuous usage, switch off the sauna for at least one hour.
- We recommend that you do not install a locking system on the sauna door.
- Check compliance of your electrical installation prior to connecting your sauna to the power supply.

Write down and keep the serial numbers of the sauna as well as the purchase invoice.

They may be requested from you during your after-sales service request.

Safety

IMPORTANT:

Please read the safety instructions carefully before installing and using your sauna cabin. They are essential for your safety, so please adhere strictly to them.

Beware of hyperthermia, heat stroke or heat exhaustion which can be caused or aggravated by noncompliance with the safety instructions. Symptoms are fever, a rapid pulse, dizziness, fainting, lethargy and numbness in all or part of the body. The effects are: reduced awareness of the heat, ignorance of imminent risks, loss of consciousness.

The sauna must not be used by:

- Children under 6 years of age.
- People with severe reactions to sunlight.
- Elderly or disabled people.
- People with previous medical conditions such as heart disease, high or low blood pressure, blood circulation problems or diabetes without prior medical advice.
- Pregnant women. Excessive temperature can endanger the foetus.
- Persons suffering from dehydration, open sores, eye disorders, burns or sunstroke.

Children between 6 and 16 years of age may use the sauna provided that they are continuously supervised by a responsible adult and that the temperature does not exceed 60°C (140°F).

In the event of problems involving health, medication or injury to muscles or ligaments, do not use the sauna without previously consulting a doctor and obtaining approval.

If surgical implants are worn, do not use the sauna without previously consulting a doctor and obtaining his approval.

Do not use the sauna after strenuous activity.

Wait 30 minutes for your body to cool down.

Do not spend more than 40 minutes in the sauna at any one time.

Do not consume alcohol or drugs before or during the session.

Do not sleep in the sauna when it is in operation.

To avoid the risk of overheating, connect your sauna to a sufficiently powerful electrical outlet and do not connect other electrical equipment to the same wall socket.

To avoid any risk of electrocution or damage to the sauna, do not use it:

- During thunderstorms.
- If the electrical cable is damaged, it must be replaced by a qualified person.
- If the electrical cable overheats, it must be checked by a qualified person.
- If you have to change a bulb, wait until the sauna is switched off and cooled down.

Dry your hands before connecting or disconnecting the electricity.

Never work with wet hands or feet.

Do not switch the electricity or the heating system rapidly on or off as this could damage the electrical system.

Do not try to repair the sauna by yourself without the agreement of the sauna's distributor or manufacturer.

Unauthorized attempts to repair it will invalidate the manufacturer's warranty.

Do not use any type of detergent inside the sauna.

Do not pile up or store objects inside or on top of the sauna.

Do not place flammable materials or chemical agents near the sauna.

Description sauna



Technical data

Model	HL-B200E
Cabin Material	Canadian spruce
Voltage	230 V - 50 Hz (excluding stove)

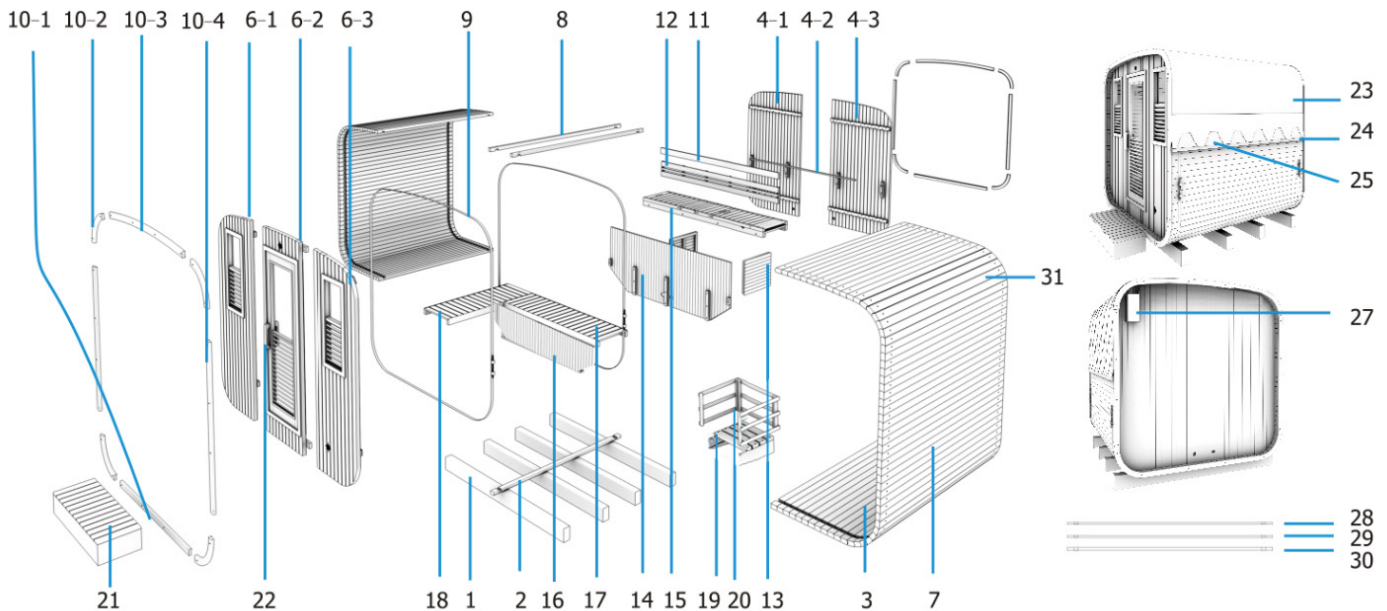
EN



N°	Quantity	Name
1	4	Barrel Cradles 1980x70x150
2	1	Special bottom slat (convex on both sides)
3	16	special bottom slat Without hole
3-2	1	special bottom slat with hole
4-1	1	Rear wall section (left)
4-2	1	Rear wall connecting bar
4-3	1	Rear wall section (right)
6-1	1	Front wall section (left window)
6-2	1	Front wall section (glass door)
6-3	1	Front wall section (right window)
7	52	1998x85x38mm standard sauna slat
8	2	76*38mm Special top slat (convex on one side)
9	2	Stainless steel sauna bands
10-1	2	Decorative eave (lower)
10-2	4	Decorative eave (corner)
10-3	2	Decorative eave (upper)
10-4	4	Decorative eave (side)
11	1	LED light beam
12	1	Backrest
13	2	Top bench panel (side)
14	1	Top bench panel (front)
15	1	Top bench panel (foldable)
16	1	Low bench braket

	Size	QTY
	Ø 5 x 50	32
	Ø 4 x 40	188
	Ø 4 x 25	8
	Ø 3 x 18	6
	Ø 3 x 16	250
	Ø 6 x 75	2
	Ø 4 x 12	4
	Allen key 1	1
	Allen key 2	1

Installation

17	1	Low bench
18	1	Side bench
19	1	Sauna stove support bracket (with water tray)
20	1	Sauna stove grill (three parts per set)
21	1	entrance step
22	1	Door handle
23	1	Rain coat (gray)
24	2	Water nose
25	100	Asphalt shingle (grey)
26	1	Wire cover
27	1	Control box
28	1	Top filling slat (10mm)
29	1	Top filling slat (15mm)
30	1	Top filling slat (20mm)
31	16	Special corner slat (70x38mm) with hole
31-2	16	Special corner slat (70x38mm) without hole

Read the assembly instructions carefully before starting.

Choice of location

Holl's saunas are designed solely for exterior installation.

Select a space:

- In a dry area, on a flat stable surface that can support the weight of your sauna.
- The height must be sufficient for you to reach the ceiling and carry out electrical connections and maintenance.
- Away from any source of water, flames or flammable materials.

A perfectly flat, level and dry concrete slab is required to install the outdoor sauna, otherwise correct assembly could be compromised.

Practical advice

- Note that sauna assembly requires 3 adults.
- Clearly identify each panel before you begin
- During assembly, position your sauna's mains cable so that it is easily accessible.
- Note that there are variations between the models.

IMPORTANT:

Please check the countersink and hole diameter of the drill holes to avoid damaging the wood.

The minimum room height required for installation is 2020 mm.

Tools needed



Screwdriver



Tape measure



Step ladder



Pencil



Cutter

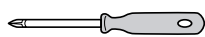

2 Spanner
(19 mm)

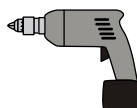

Electric
screwdriver

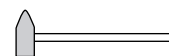

Mallet



Wood spiral drill



Allen Wrench

Assemble instructions

Assemble steps

Step 1:

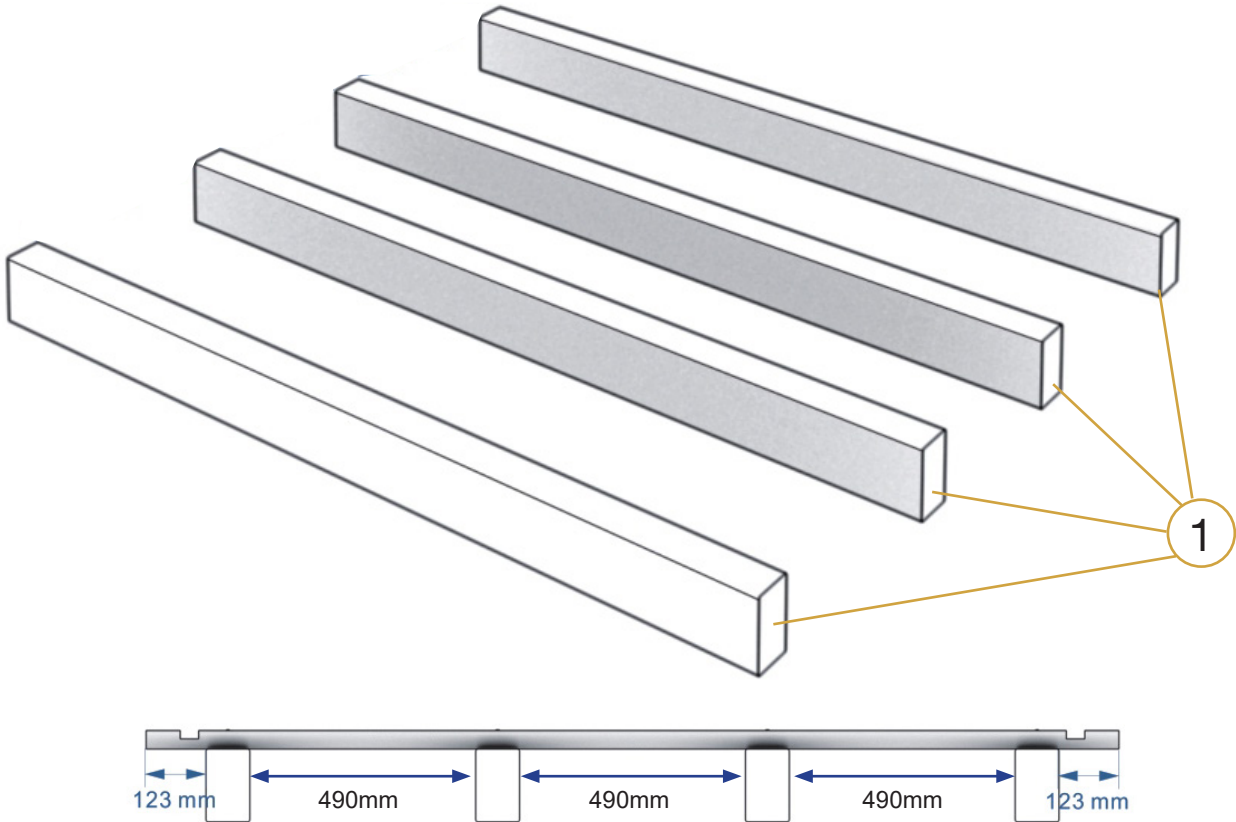

Step 2:

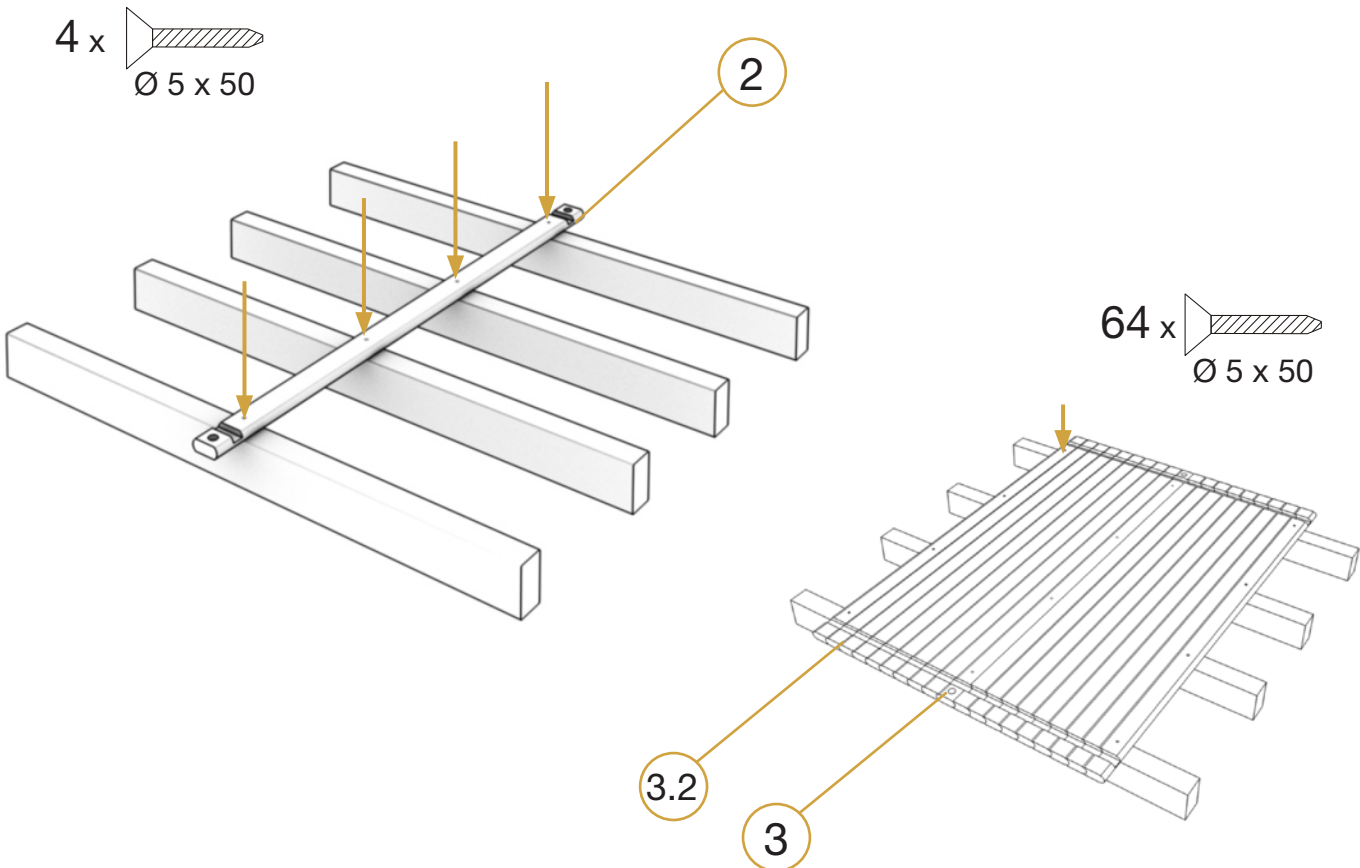

Assemble instructions

Step 3:

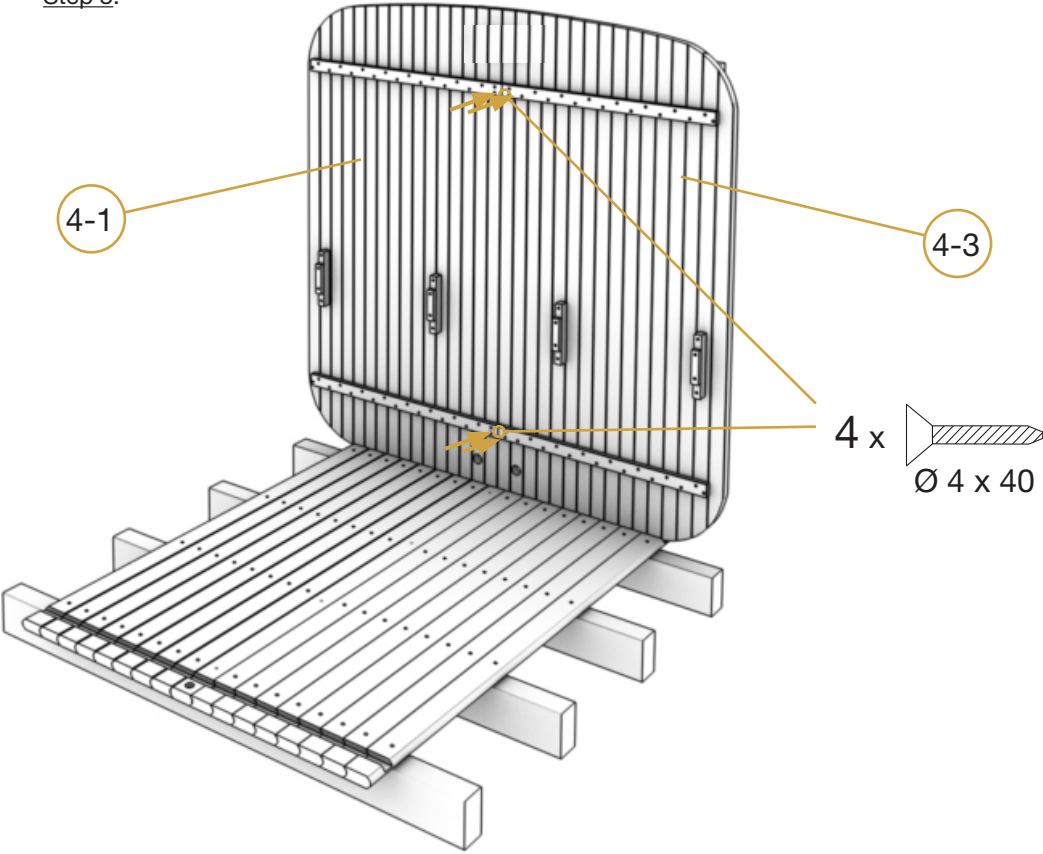

Step 4:

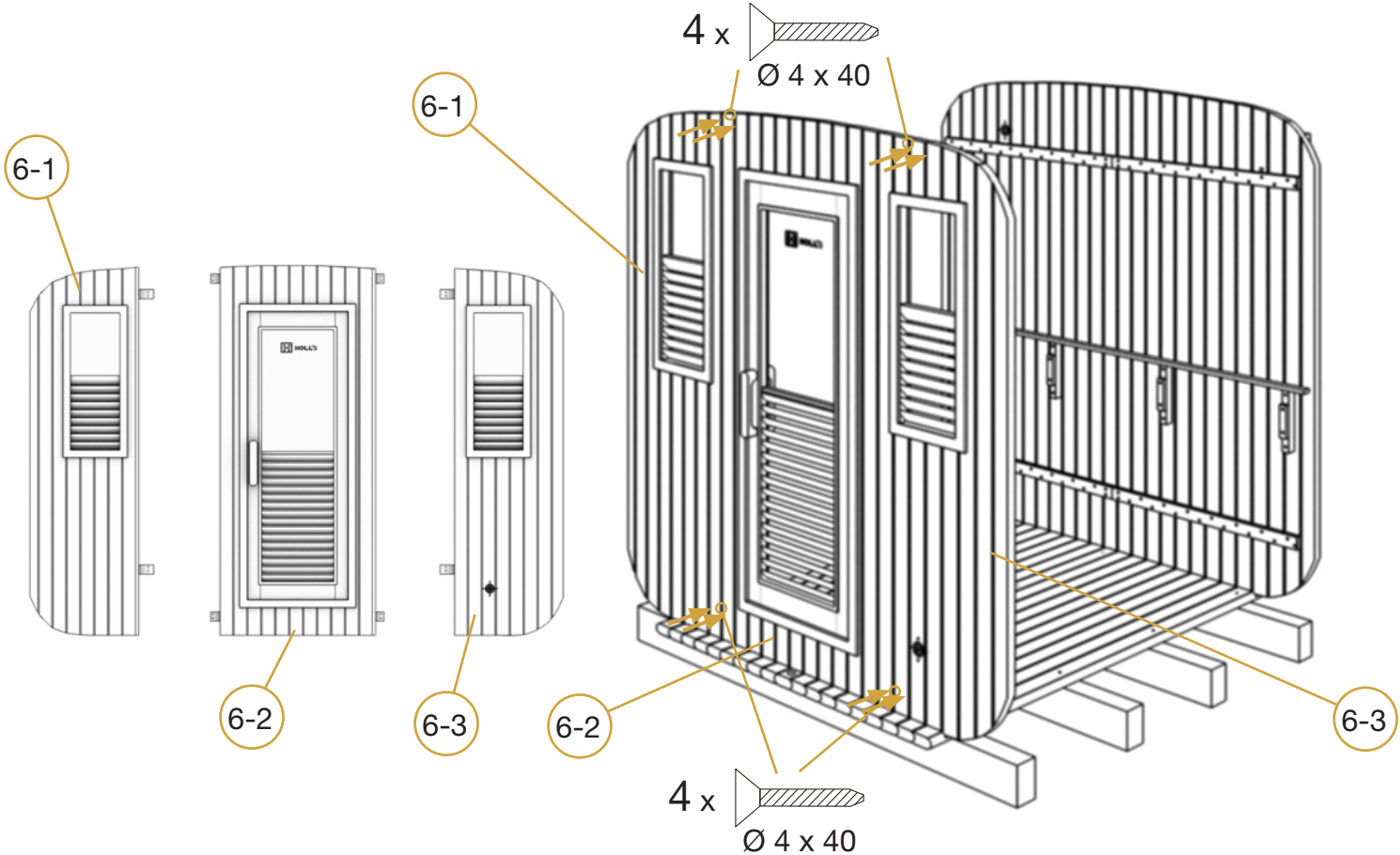

Assemble instructions

Step 5:

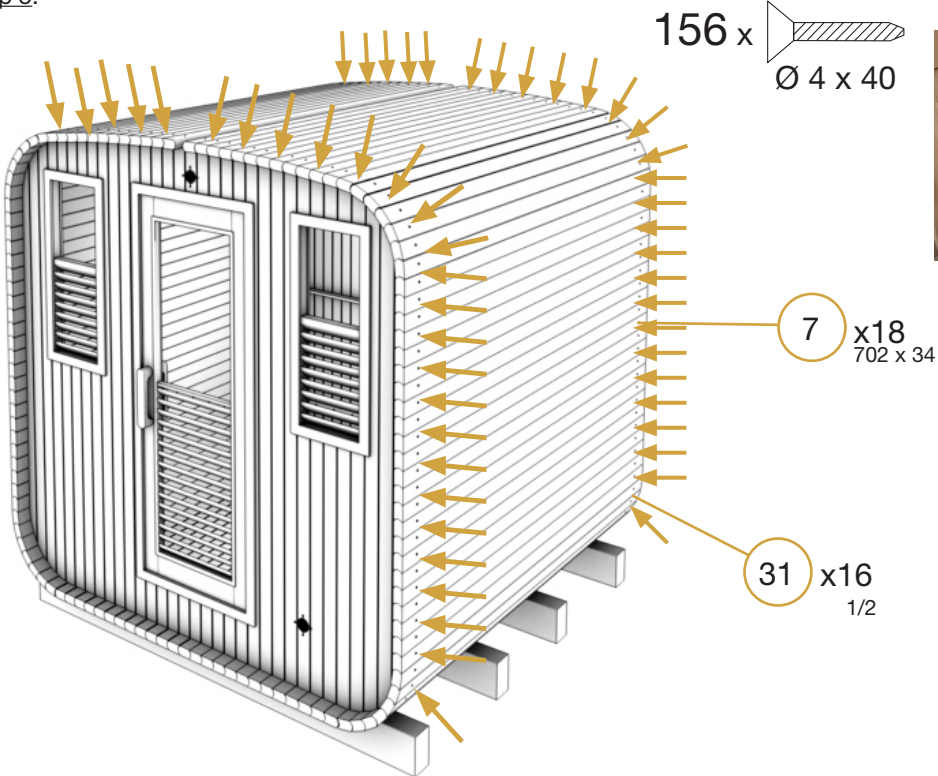

EN

Step 6:

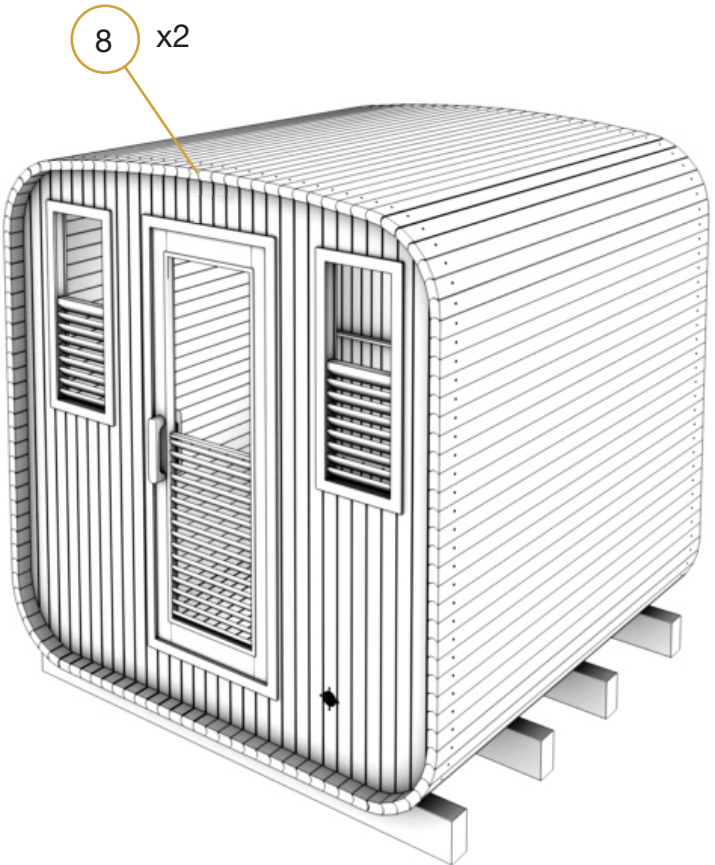

28 / 29 / 30

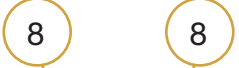

Assemble instructions

Step 7:

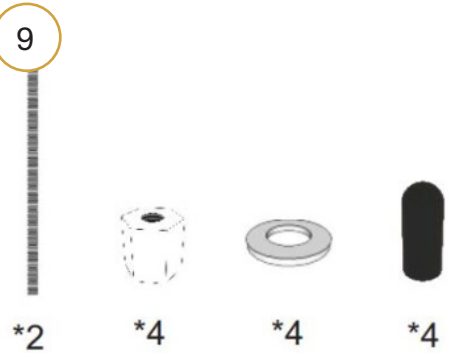
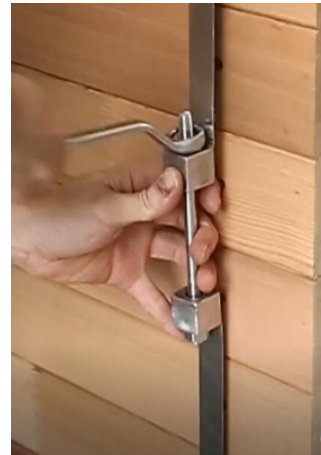
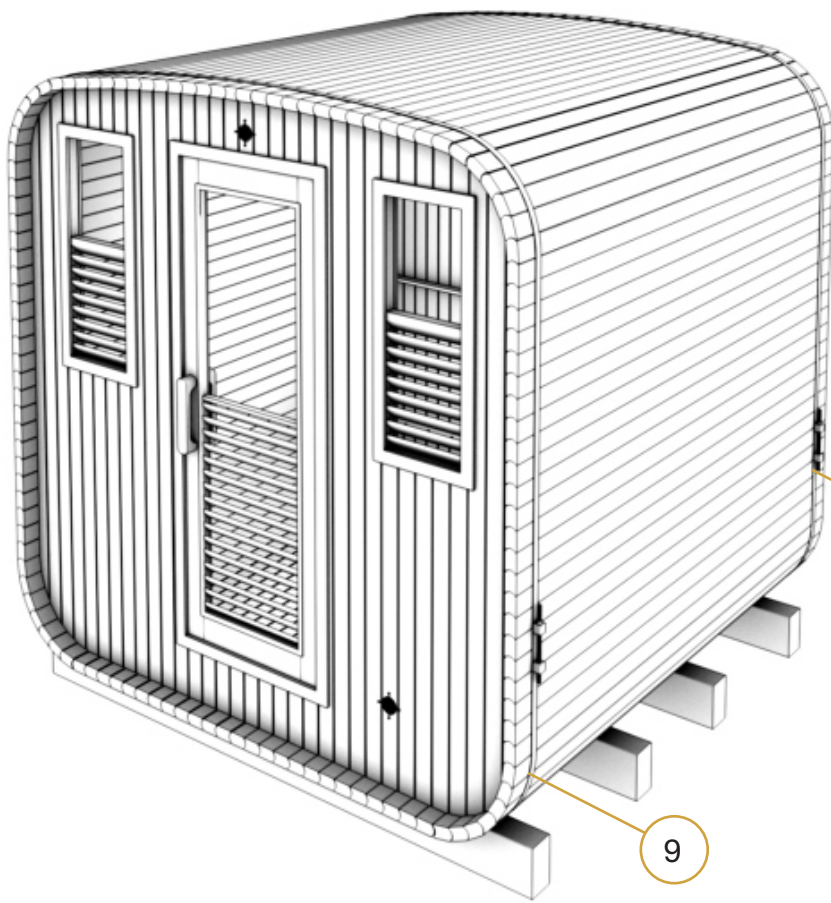

Step 8:

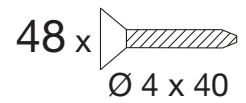
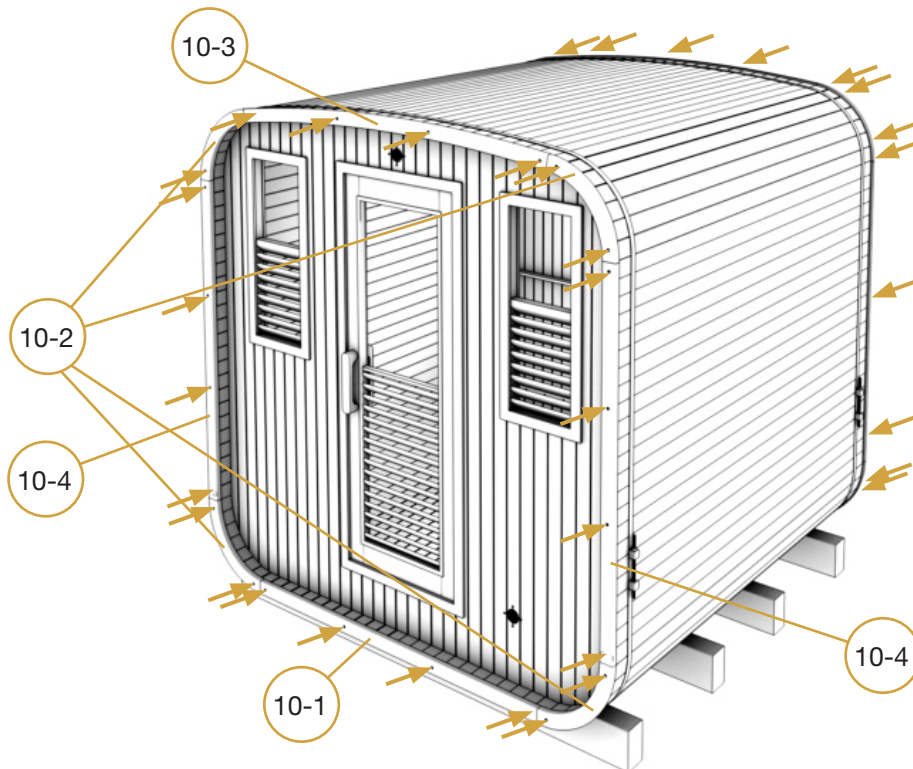

Assemble instructions

Step 9:

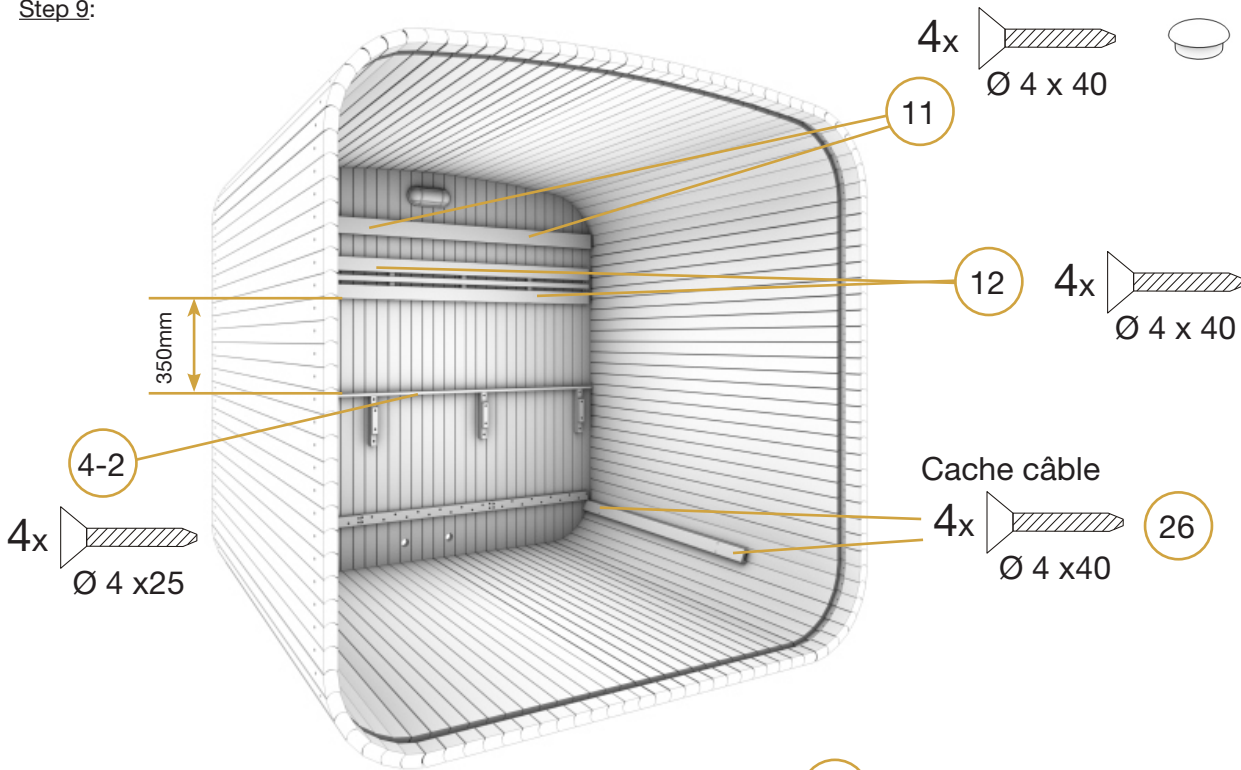

Step 10:

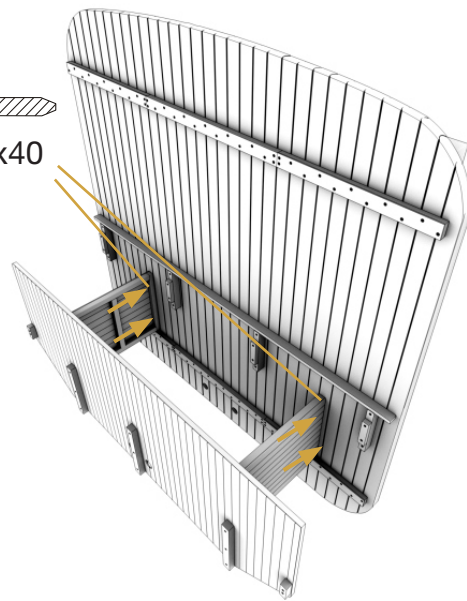
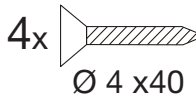
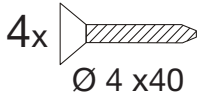
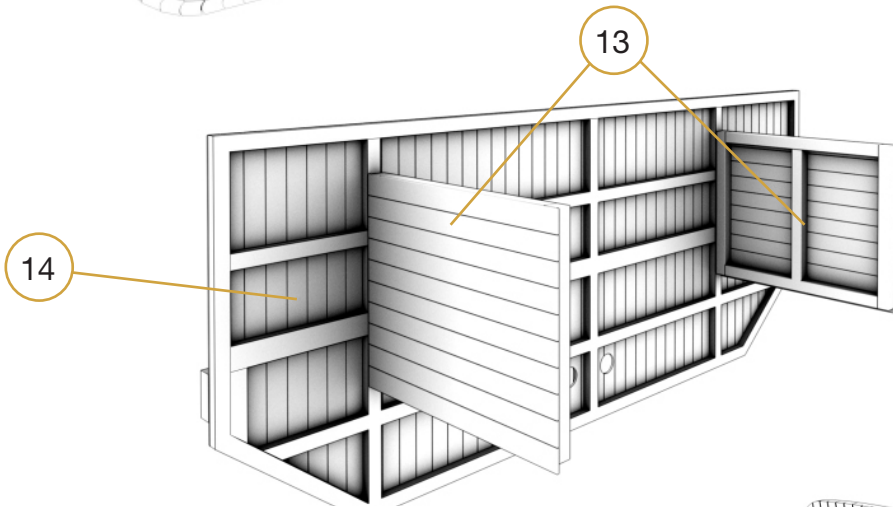

Assemble instructions

Step 11:

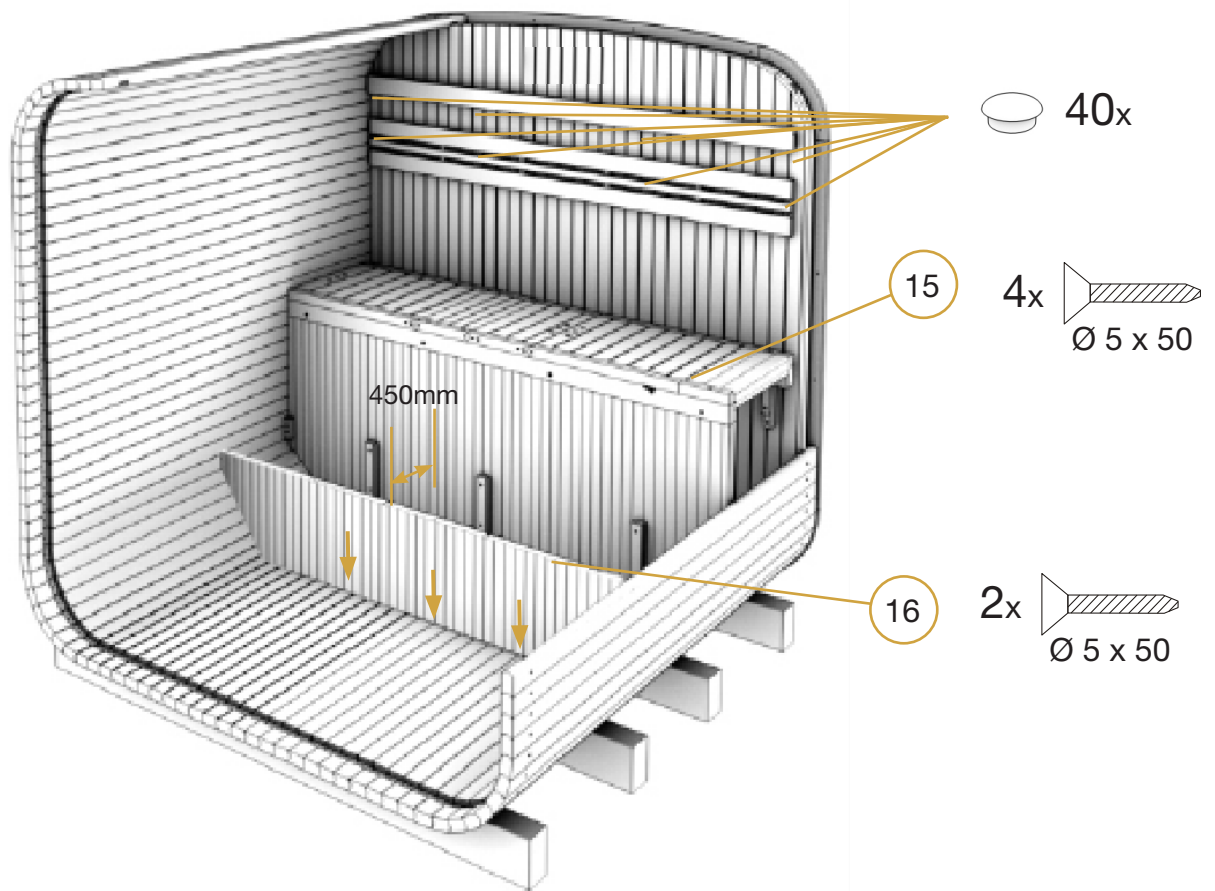

Step 12:

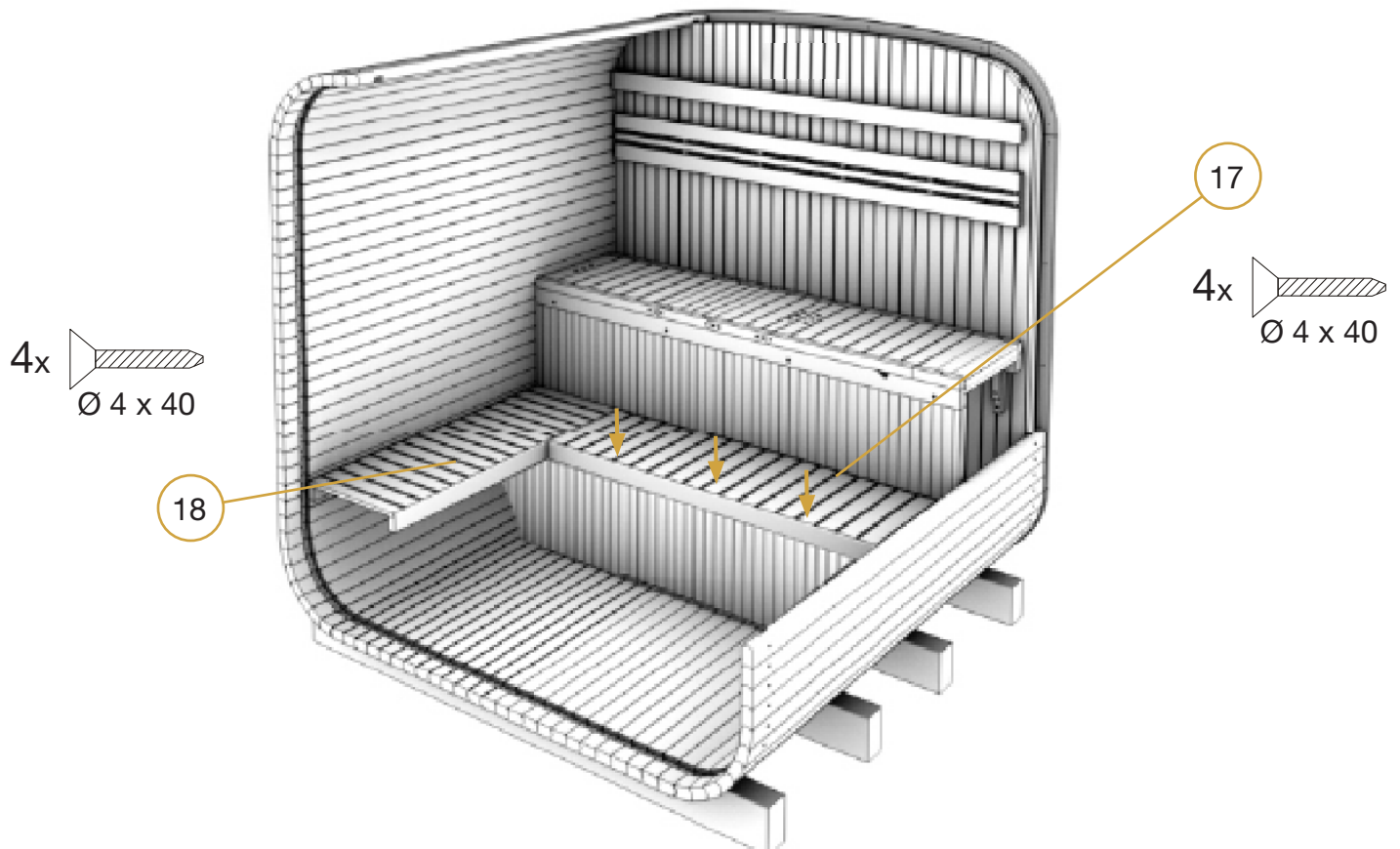

Assemble instructions

Step 13:

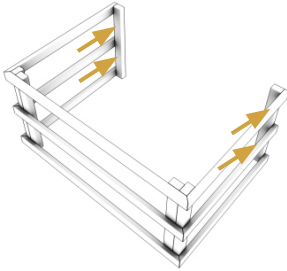
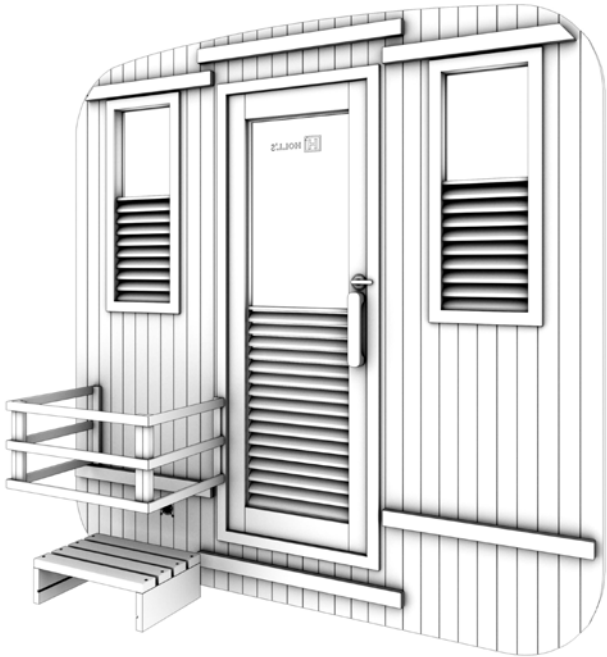

EN

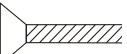
2x 
Ø 5 x 50

19

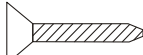
8x 
Ø 4 x 40

20

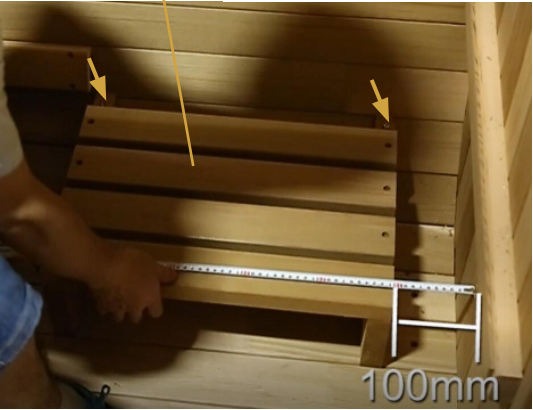

Step 14:



2x 
Ø 6 x 70

21

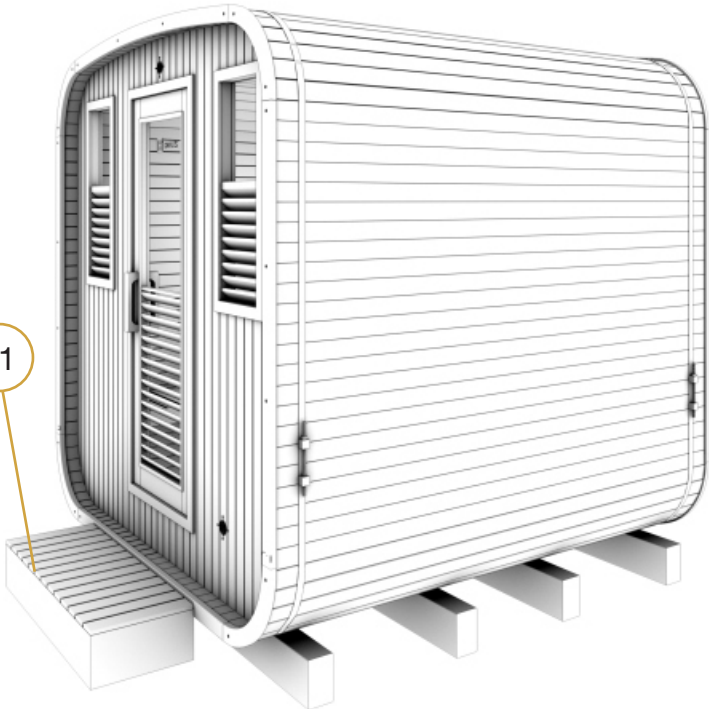

Assemble instructions

IMPORTANT:

The roof cover is essential for sauna waterproof, adapt it to according to the environment.

Step 15:

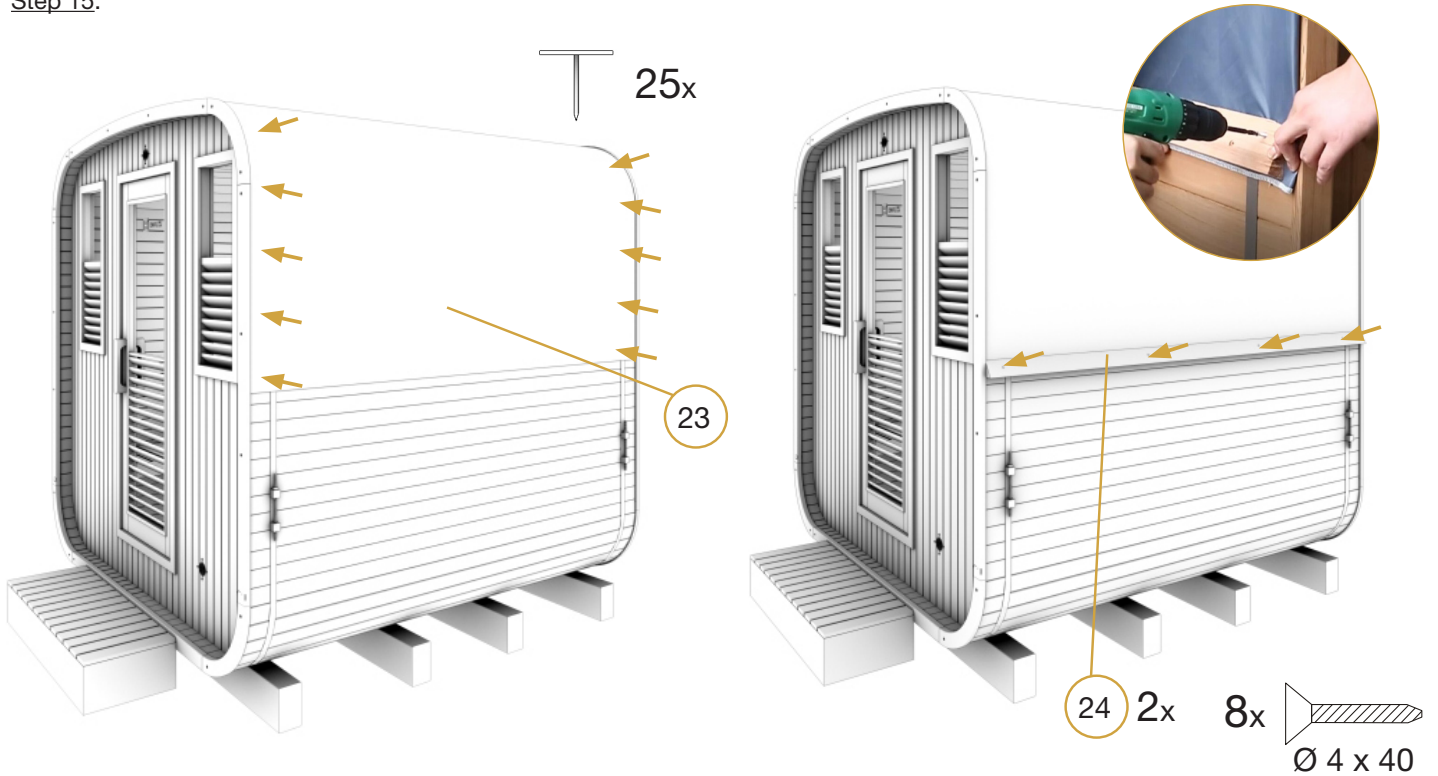

Step 16:

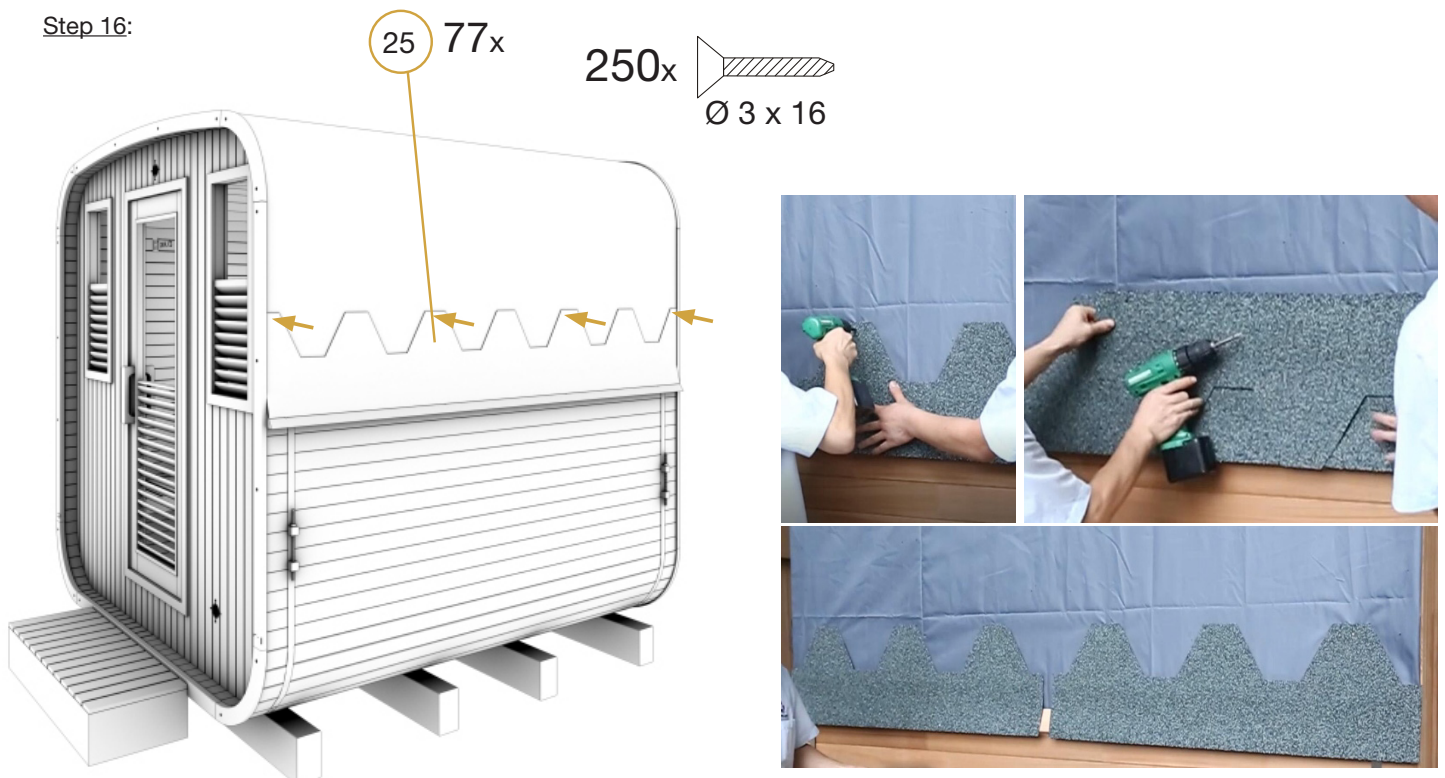

Assemble instructions

Step 17:

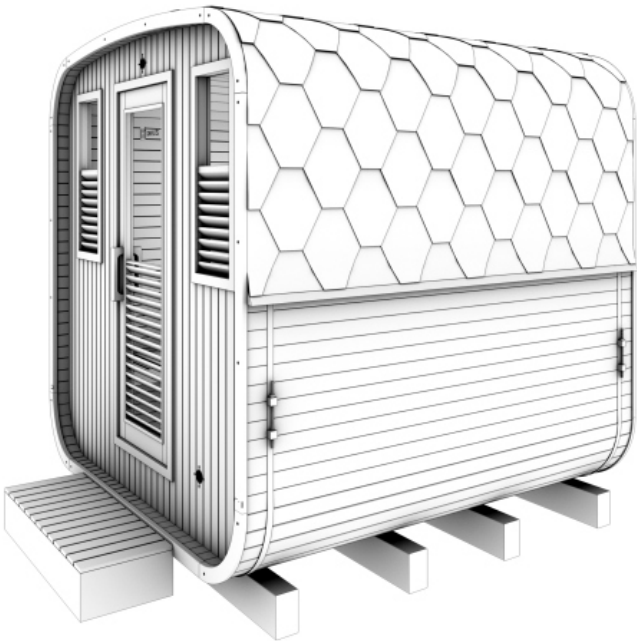

EN

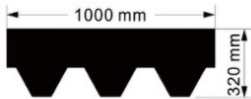
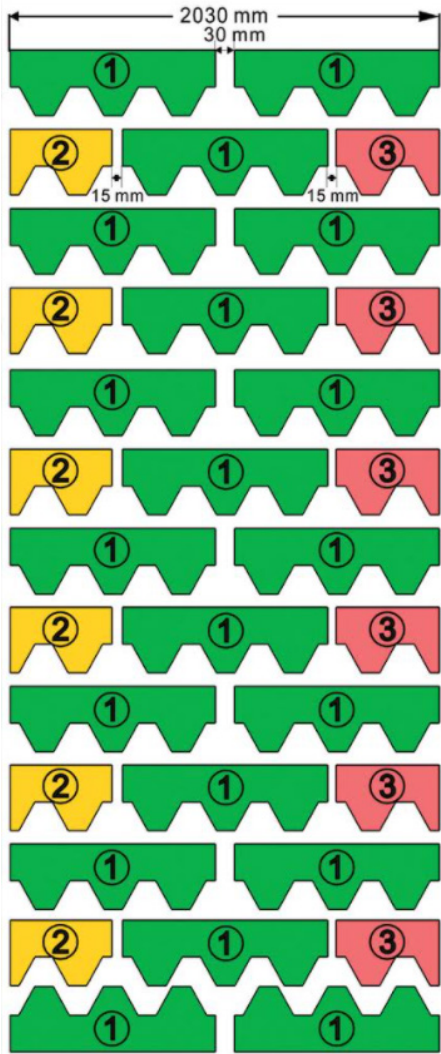

① 1000*320=49

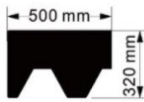

② 500*320=14

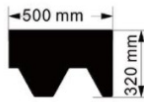

③ 500*320=14

Step 18:

4x  Ø 4 x 25

27

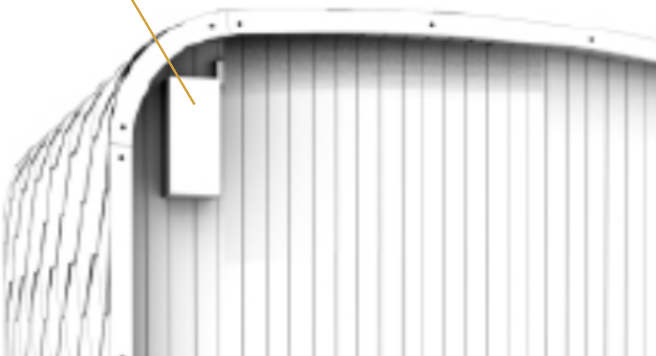

1: connect

2: fix



Maintenance & servicing

Protection of wood

Brush each exterior barrel slat and apply a wood stain when full assembly to protect the wood.
This wood stain had to be renewed according to the recommendations of the product used

Maintenance

IMPORTANT:

Disconnect the cabin's power supply cable before undertaking any work.

Problems identified	Possible reasons	Solutions
Electric stove does not heat up.	Power supply cable disconnected.	Check power supply cable connection.
	The general power supply is cut.	Check that the switchboard and wall plug are working.
	Stove is overheat protected.	Refer to the electric stove manual.
Sauna light fitting no longer work.	Light cable not fully plug.	Plug the cable.
	Light is defective.	Contact your dealer.

Servicing

1. Disconnect your sauna.
2. Use a vacuum cleaner to remove dust from crevices in the woodwork.
3. Clean the cabin with a damp cotton cloth and use a small amount of soap if necessary. Rinse with a damp cloth.
4. Clean the glass with a window / glass cleaner and a soft cloth.
5. Maintain the exterior of the sauna every 2 years with a suitable product.
6. In the event of heavy rain, oreoles may appear inside the sauna, this is not a leak due to capillary action.

IMPORTANT:

The wood should be treated with a protective product only on the outside of the sauna.

No treatment should be applied inside the sauna.

Do not use benzene, alcohol, chemical agents or strong detergents on the sauna since chemical products can damage the wood. Do not spray water on your sauna.

Warranty

All the components of Holl's saunas are guaranteed for 2 years and 4 years for wooden parts.

The warranty comes into force on the date of dispatch (corresponding to the date the invoice is issued).

The warranty does not apply in the following cases:

- Malfunction or damage arising from installation, usage or repair that are not in compliance with the safety instructions.
- Malfunction or damage arising from conditions that are unsuitable for the equipment's originally intended purpose.
- Damage arising from negligence, accident or force majeure (thunderstorm or bad weather).
- Malfunction or damage arising from the use of non-authorized accessories.
- Malfunction or damage resulting from the non-installed of a waterproof roof.
- Malfunction or damage resulting from the non-maintenance of the outside of the sauna.

The warranty does not cover the costs linked to returning the cabin or part of its components to our workshops of. Under the warranty, in the event of a breakdown, the items deemed defective by our technicians will be exchanged. Information and explanations required for their installation will be provided by one of our technicians. Costs linked to the use of subcontract labour provided by a third party cannot be covered by Holl's.



IMPORTANT

Do not return the product to the store

Contact your local after sales service on
www.holls.fr or POOLSTAR

960 Avenue Olivier Perroy, 13790 ROUSSET - FRANCE

LED Controller

	LED control box	Remote control
Operating temperature	-30°C / 60°C	-30°C / 60°C
Tension	CD5V / 12/24V DC	2 piles NO7 - 3V
output	3 channels N-MOS drain open output	-
Power consumption	0.5W	0.09mW
Output	6A 3 canaux : 18A 6A	
Dimensions of the box	83 x 79 x 33cm	

Fonctions :

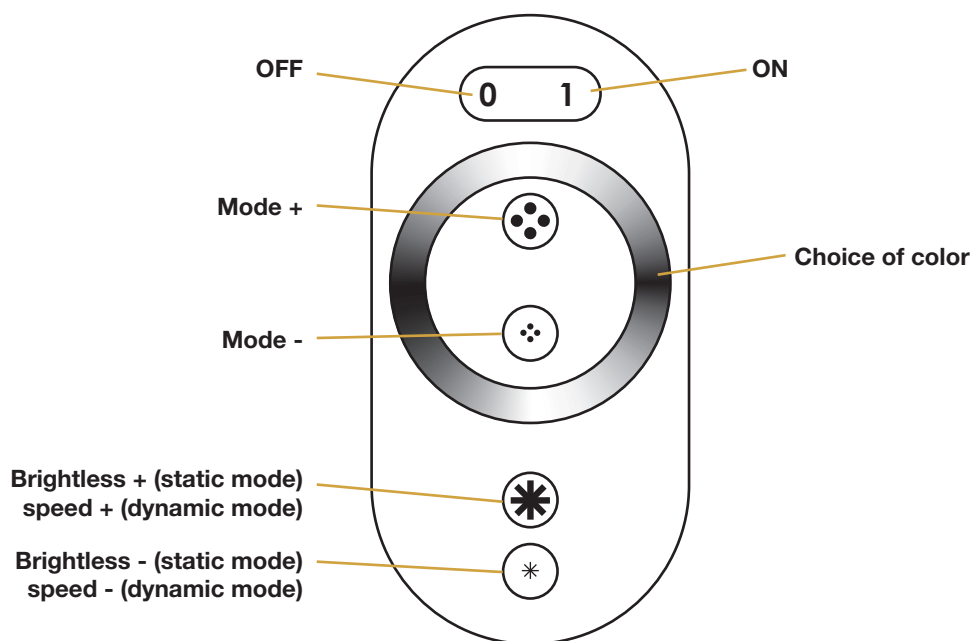

Mode	lighting	comments		
1	static red (R)	Brightness adjustable	10	3 color transition (G / B / R)
2	static green (G)		11	5 color transition (G / B / P / R / Y)
3	static blue (B)		12	7 color transition (G / B / Y / P / LB / W / R)
4	static yellow (Y)		13	5 color wave (R / Y / G / B / W)
5	static purple (P)		14	3 color flash (R / G / B)
6	static light blue (LB)		15	7 color flash (W / R / G / B / Y / P / LB)
7	static white (W)		16	3-color dynamic flash (R / G / B)
8	Jump between 3 colors (G / B / R)	Adjustable speed and brightness	17	7-color dynamic flash (R / G / B / Y / P / LB / W)
9	Jump between 7 colors (R / G / B / Y / P / LB / W)		18	Automatic

Advertencias

Lea detenidamente este manual antes de utilizar su sauna por primera vez.

Le aconsejamos que lo guarde en un lugar seguro para futuras consultas.

- La madera es un elemento vivo, para mantener su apariencia original, es importante tratar el exterior de la madera contra la humedad.
Use un saturador solo en el exterior de la sauna.
- Instale la sauna en una superficie plana.
- La sauna debe situarse en un lugar seco. No la utilice en las inmediaciones de una fuente de humedad (bañeras, suelos húmedos, piscinas, etc.).
- No utilice productos de limpieza líquidos. Desconecte la sauna antes de proceder a limpiarla y utilice un trapo húmedo (consulte el capítulo sobre mantenimiento).
- Proteja el cable eléctrico de la sauna para evitar pisarlo o aplastarlo.
- Antes de cambiar cualquier pieza, asegúrese de que se trata de repuestos especificados por el fabricante o de que sus características son semejantes a las de las piezas originales. Cualquier repuesto no apto podría dar lugar al deterioro de la sauna o provocar un incendio o cortocircuito. Le aconsejamos encarecidamente que se ponga en contacto con un técnico cualificado.
- Para evitar el riesgo de quemaduras o descargas eléctricas, no utilice ningún objeto metálico.
- No meta ningún animal dentro de la sauna.
- No deje la sauna encendida sin supervisión.
- No deje la sauna encendida durante más de 3 horas seguidas o el equipo podría deteriorarse prematuramente. Después de 3 horas de uso continuo, permita que la sauna descanse durante al menos una hora.
- Le aconsejamos que no instale un sistema de cierre en la puerta de la sauna.
- Verifique la conformidad de su instalación eléctrica antes de proceder a la conexión eléctrica de la sauna.

Anote y conserve los números de serie de la sauna así como la factura de compra.

Se le pueden solicitar durante su solicitud de servicio posventa.

Seguridad

ATENCIÓN:

Lea detenidamente las instrucciones de seguridad antes de instalar y utilizar la cabina de la sauna. Son fundamentales para su seguridad, por lo que debe asegurarse de respetarlas en todo momento.

En caso contrario, podría provocarse o acentuarse una hipertermia, una insolación o un golpe de calor. Entre sus síntomas se incluyen fiebre, aceleración del pulso, vértigo, desmayos, letargia y entumecimiento del cuerpo o de alguna parte del cuerpo. Efectos: Falta de percepción del calor, desconocimiento del riesgo inminente, pérdida del conocimiento.

Las siguientes personas no deberían utilizar la sauna:

- Los niños menores de 6 años.
- Las personas que sufren reacciones significativas ante los rayos del sol.
- Las personas mayores o discapacitadas.
- Las personas con antecedentes médicos como enfermedades cardíacas, hipertensión/hipotensión, problemas de circulación sanguínea o diabetes sin haber consultado antes con un médico.
- Las mujeres embarazadas, ya que la temperatura excesiva puede ser peligrosa para el feto.
- Las personas que padecen deshidratación, enfermedades oculares, quemaduras o golpes de sol, o que poseen heridas abiertas.

Los menores de entre 6 y 16 años pueden utilizar la sauna siempre y cuando se disponga de la supervisión de un adulto en todo momento y que la temperatura no exceda los 60 °C (140 °F).

Si padece cualquier problema de salud, lesión muscular o de los ligamentos, o está tomando algún medicamento, no utilice la sauna sin consultar previamente con un médico.

En caso de implantes quirúrgicos, no utilice la sauna sin consultar previamente con un cirujano.

No utilice la sauna después de haber realizado un esfuerzo físico considerable. Espere 30 minutos hasta que su cuerpo se haya enfriado.

No permanezca en la sauna durante más de 40 minutos.

No consuma alcohol ni ingiera drogas antes o durante la sesión en la sauna.

No se duerma dentro de la sauna mientras esté en funcionamiento.

A fin de evitar el riesgo de sobrecalentamiento, enchufe la sauna a una toma de corriente de la potencia adecuada y no enchufe otros aparatos eléctricos a dicha toma.

Para evitar cualquier riesgo de electrocución o deterioro de la sauna, no la utilice:

- Durante una tormenta.
- Si el cable eléctrico se ha deteriorado, deberá sustituirlo un técnico cualificado.
- Si el cable eléctrico se ha sobrecalentado, deberá comprobarlo un técnico cualificado.
- Si se debe cambiar una bombilla, espere a que la sauna esté apagada y se haya enfriado.

Séquese las manos antes de activar o desactivar la corriente. No manipule nunca el equipo con las manos o los pies húmedos.

No active y desactive la corriente o el sistema de calentamiento varias veces de manera rápida, ya que podría dañar la instalación eléctrica.

No intente reparar la sauna por su cuenta sin previo acuerdo del distribuidor o fabricante de la sauna. Cualquier intento de reparación no autorizado anulará la garantía del fabricante.

No utilice ningún tipo de detergente en el interior de la sauna.

No apile ni almacene objetos dentro o encima de la sauna.

No coloque materiales inflamables o agentes químicos cerca de la sauna.



Descripción de la sauna

Características técnicas

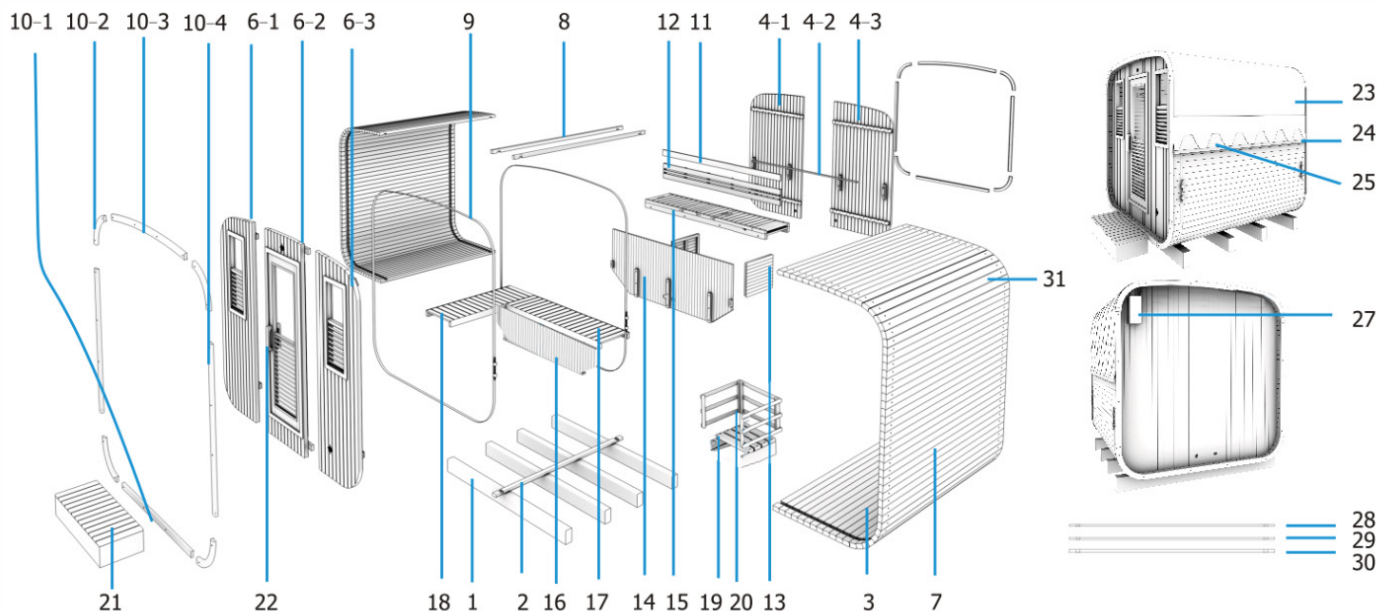
Modelo	HL-B200E
Madera	abeto canadiense
Tensión	230 V - 50 Hz (excluyendo estufa)

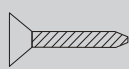

N°	CANT.	Name
1	4	Cunas de barril 1980x70x150
2	1	Listón inferior especial (convexo en ambos lados)
3	16	lamas laterales especiales sin agujeros
3-2	1	lamas laterales especiales con agujeros
4-1	1	Sección de la pared trasera (izquierda)
4-2	1	Barra de conexión de la pared trasera
4-3	1	Sección de la pared trasera (derecha)
6-1	1	Sección de pared frontal (ventana izquierda)
6-2	1	Sección de pared frontal (puerta de vidrio)
6-3	1	Sección de pared frontal (ventana derecha)
7	52	Listón de sauna estándar 1998x85x38mm
8	2	Listón superior especial de 76 * 38 mm (convexo en un lado)
9	2	Bandas de sauna de acero inoxidable.
10-1	2	Alero decorativo (inferior)
10-2	4	Alero decorativo (esquina)
10-3	2	Alero decorativo (superior)
10-4	4	Alero decorativo (lateral)
11	1	Haz de luz LED
12	1	Respaldo
13	2	Panel superior de banco (lateral)
14	1	Panel de banco superior (frente)
15	1	Panel superior de banco (plegable)
16	1	Braket de banco bajo

	Tamaño	CANT.
	Ø 5 x 50	32
	Ø 4 x 40	188
	Ø 4 x 25	8
	Ø 3 x 18	6
	Ø 3 x 16	250
	Ø 6 x 75	2
	Ø 4 x 12	4
	Allen key 1	1
	Allen key 2	1

ES

Instalación

17	1	Banco bajo
18	1	Banco lateral
19	1	Soporte de estufa para sauna (con bandeja de agua)
20	1	Parrilla para estufa de sauna (tres partes por juego)
21	1	paso de entrada
22	1	Manija de la puerta
23	1	Chubasquero (gris)
24	2	Nariz de agua
25	100	Teja de asfalto (gris)
26	1	Cubierta de alambre
27	1	Caja de control
28	1	Listón de llenado superior (10 mm)
29	1	Listón de llenado superior (15 mm)
30	1	Listón de relleno superior (20 mm)
31	16	Lama esquina especial (70x38mm) con agujero
31-2	16	Lama esquina especial (70x38mm) sin agujero

Antes de proceder al ensamblaje, lea detenidamente las instrucciones de montaje.

Elección de una ubicación

Las saunas Holl's se han diseñado para instalarse en exteriores.

Elija un lugar:

- Seco, en una superficie plana y estable, y capaz de soportar el peso de la sauna.
- La altura debe ser tal que le permita acceder al techo y realizar la instalación eléctrica, así como tareas de mantenimiento.
- Coloque la sauna alejada de cualquier fuente de humedad, llama o sustancia inflamable.

Para instalar la sauna de exterior se requiere una losa de hormigón perfectamente plana, nivelada y seca, ya que de lo contrario podría comprometerse el correcto montaje.

Consejos prácticos

- Tenga en cuenta que para montar la sauna se requieren 2 o 3 adultos.
- Identifique claramente cada panel antes de comenzar.
- Durante el montaje, coloque el cable de alimentación de la sauna de manera que pueda acceder a él fácilmente.
- Tenga en cuenta que las características de los distintos modelos varían.

ATENCIÓN:

Compruebe los orificios y sus diámetros para evitar dañar la madera.

La altura mínima requerida para la instalación es de 2020 mm.

Tools needed

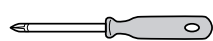

Destornillador de cruz



Cinta métrica



Alzador



Lápiz



Cuchilla



2 Llave (19 mm)

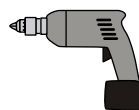

Destornillador eléctrico

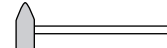

Mazo



Wood spiral drill



Allen Wrench

Ensamblaje

Etapas del montaje

Etapa 1:

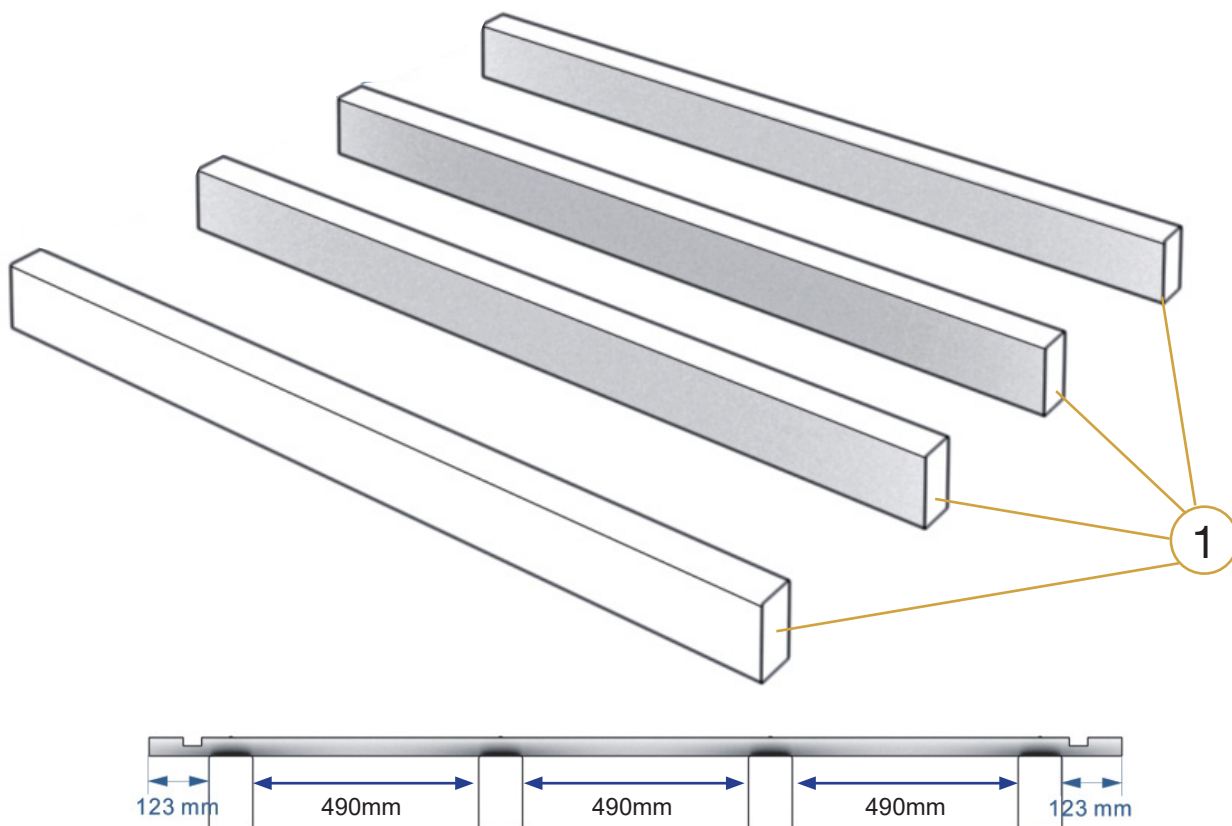

Etapa 2:

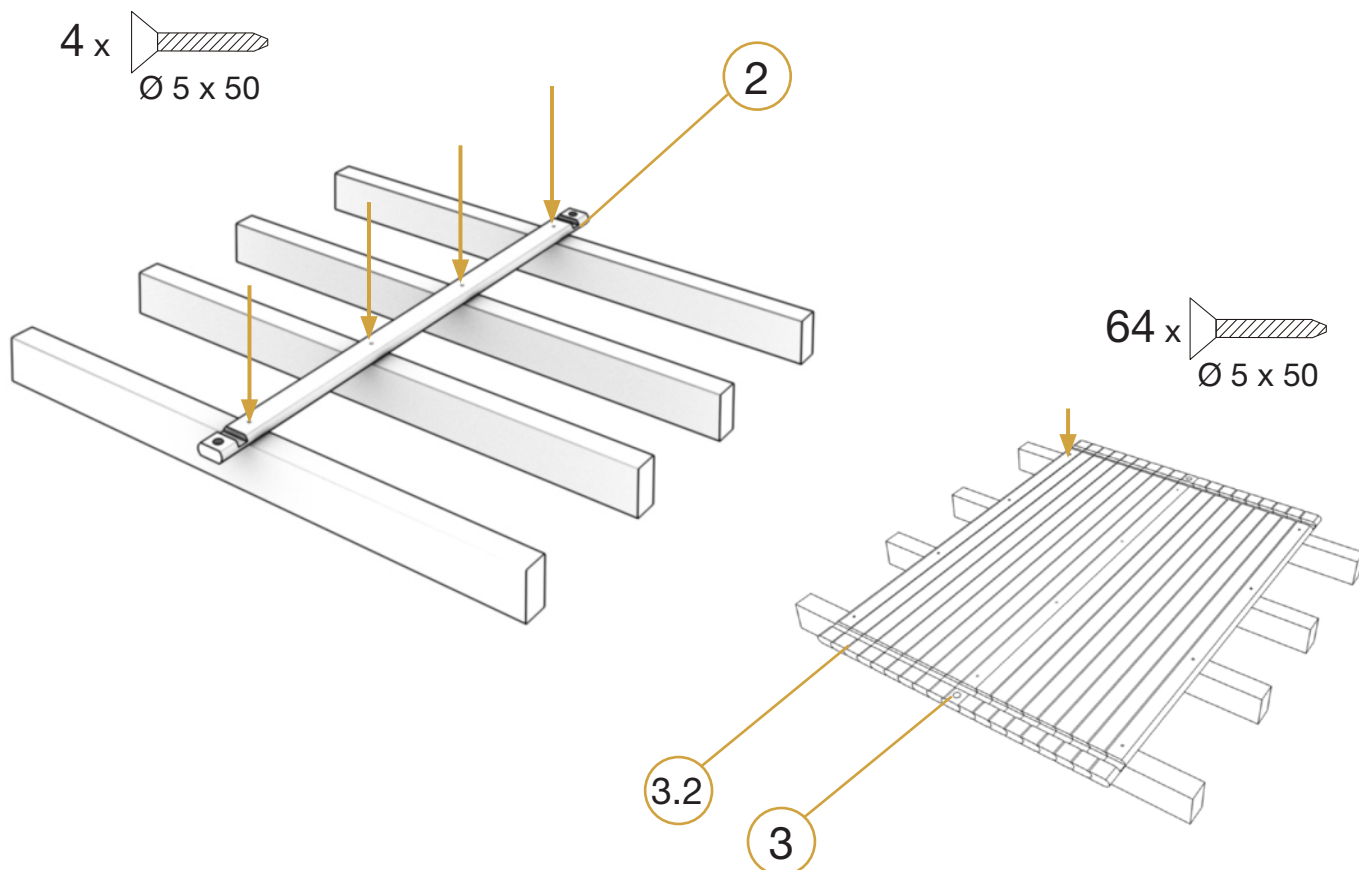

Ensamblaje

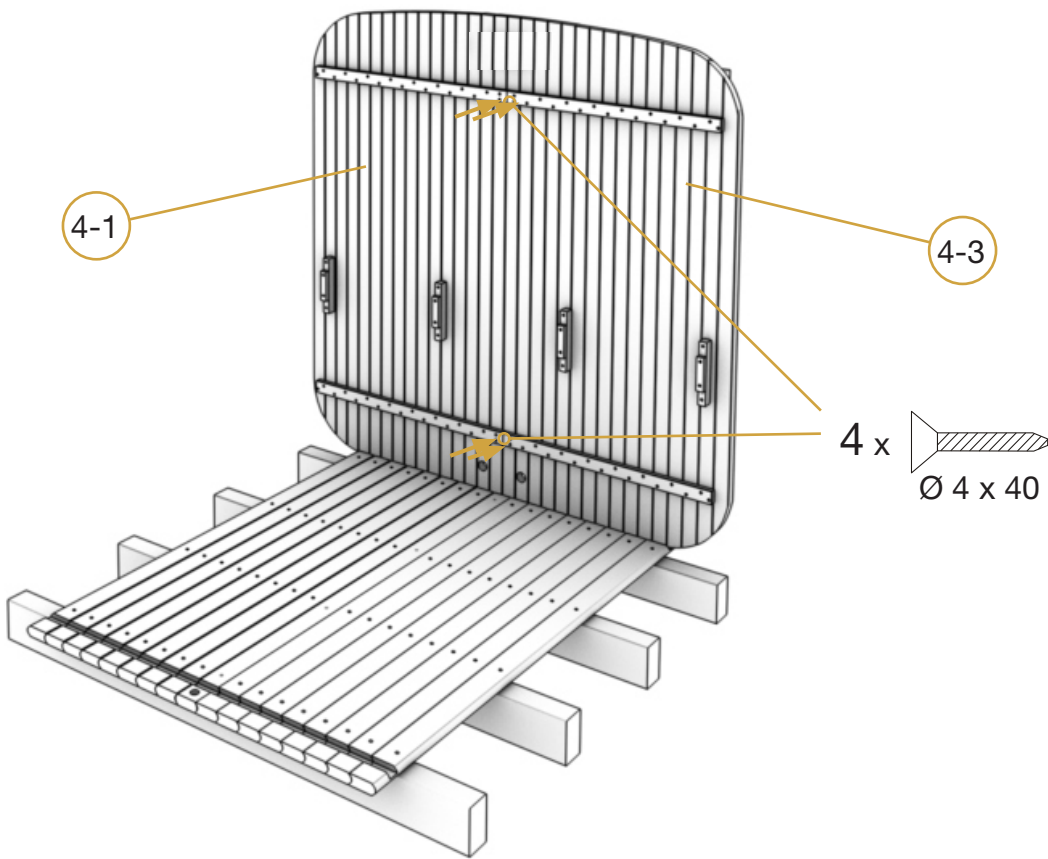

Etapa 7.

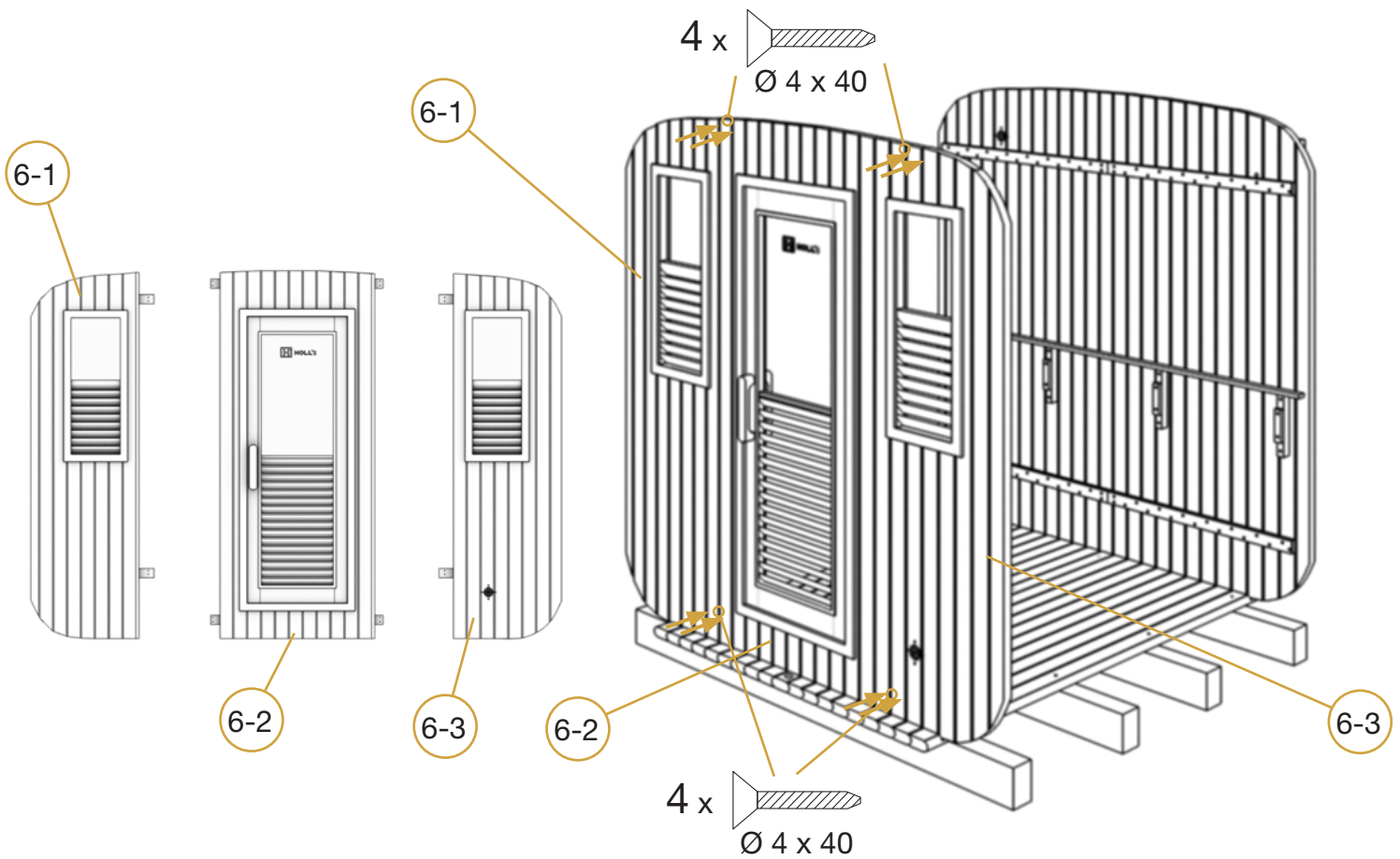

Ensamblaje

Etapa 5:

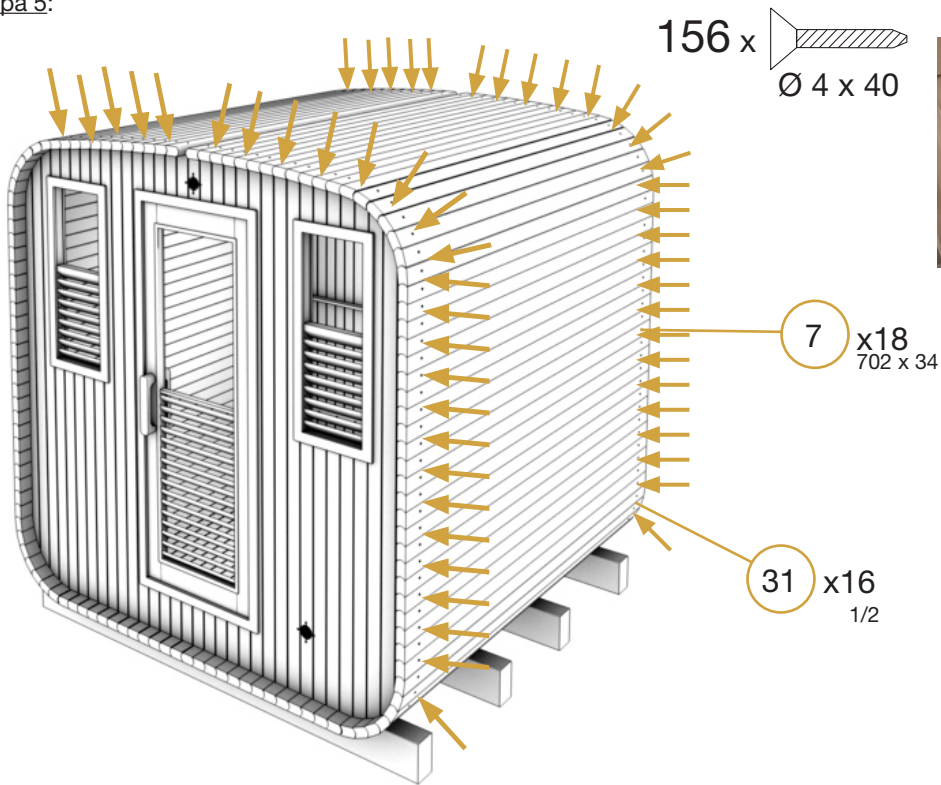

Etapa 6:

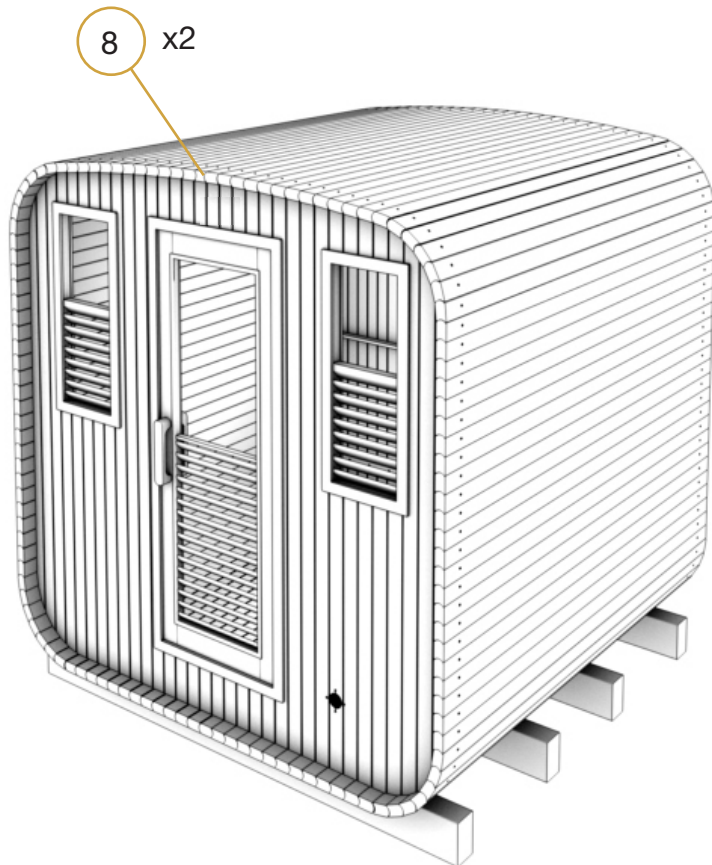

28 / 29 / 30

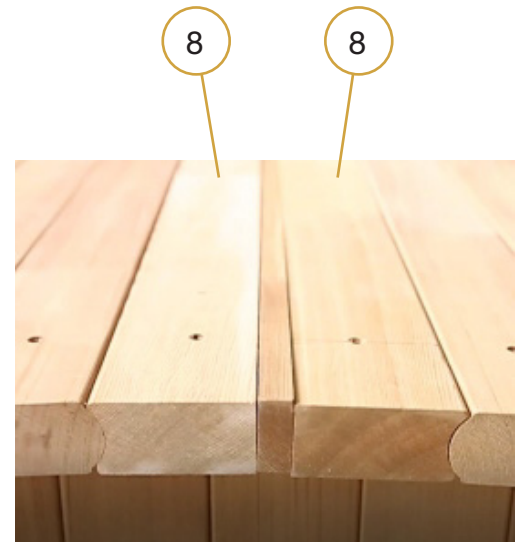

Ensamblaje

Etapa 7:

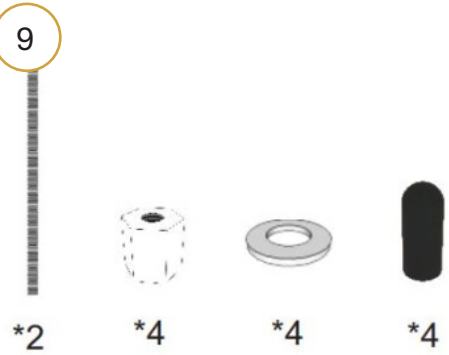
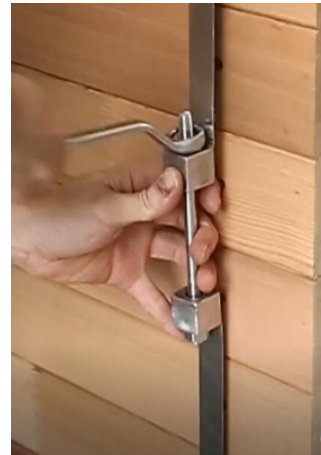
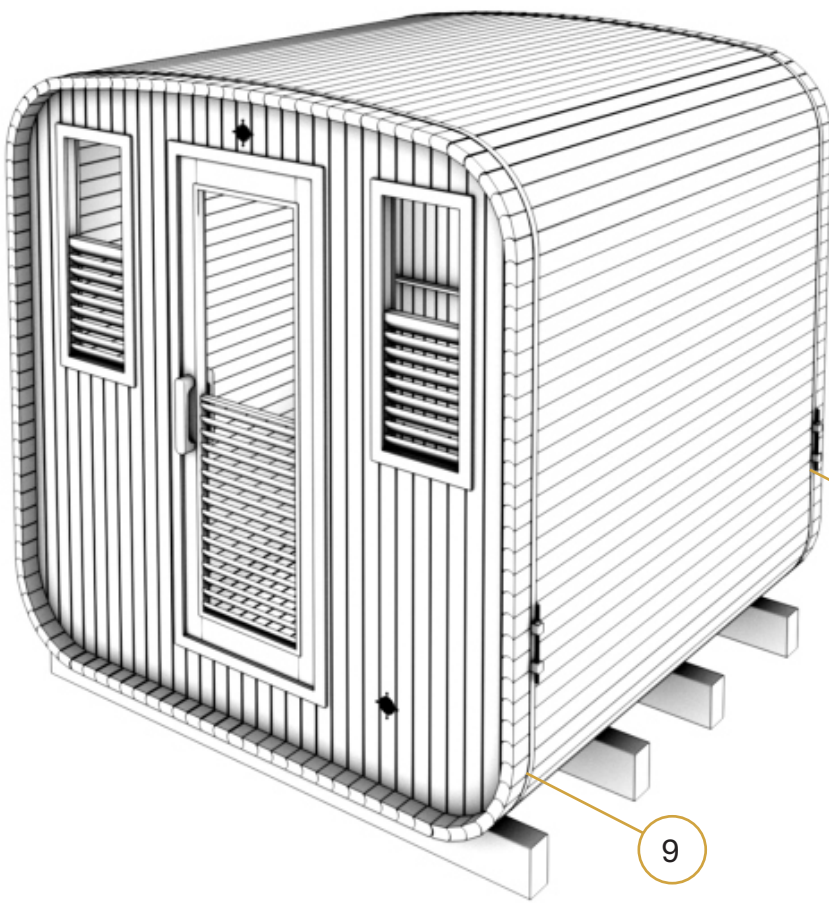

Etapa 8:

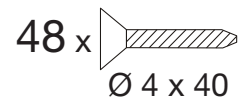
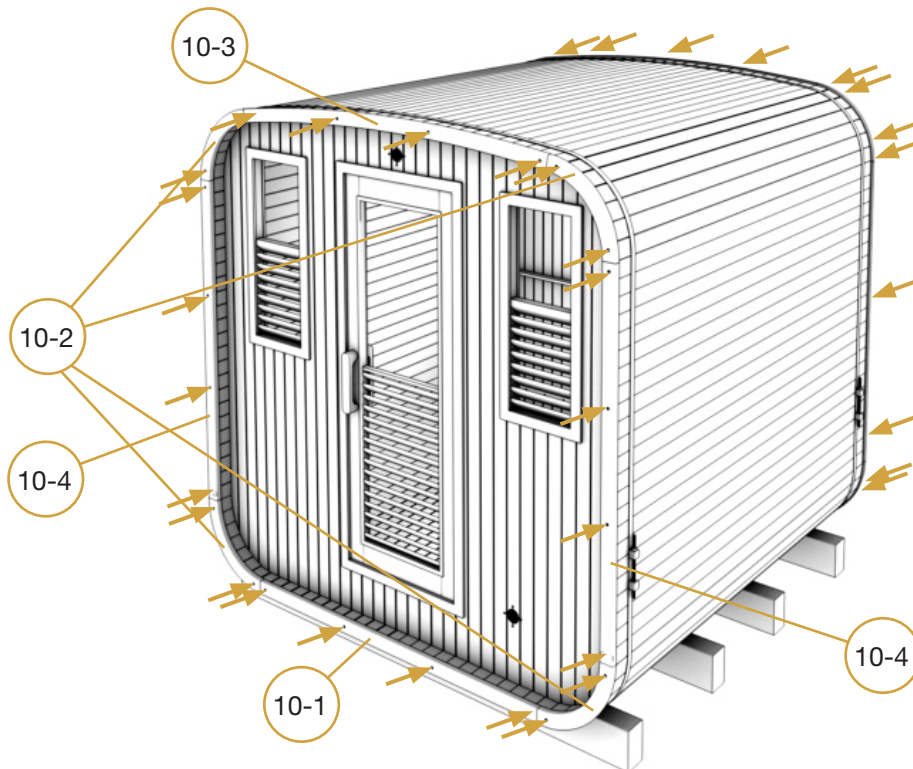

Ensamblaje

Etapa 9:

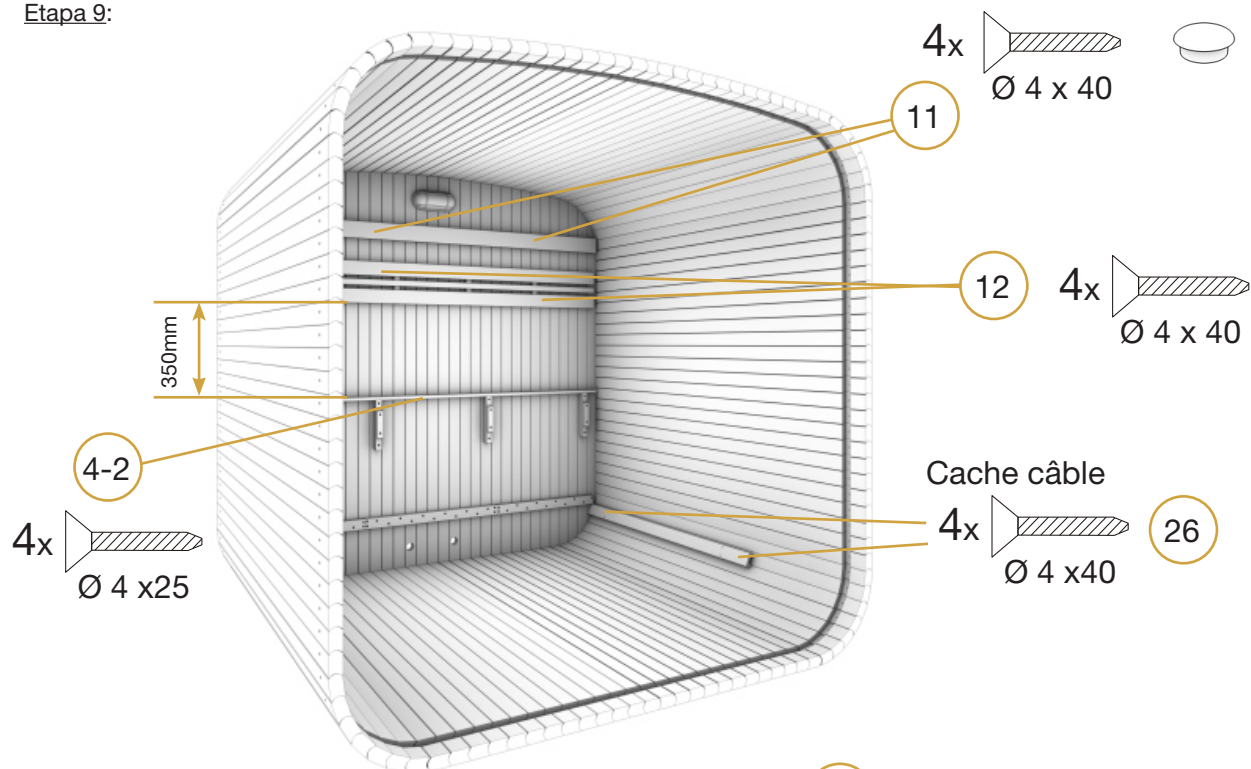

Etapa 10:

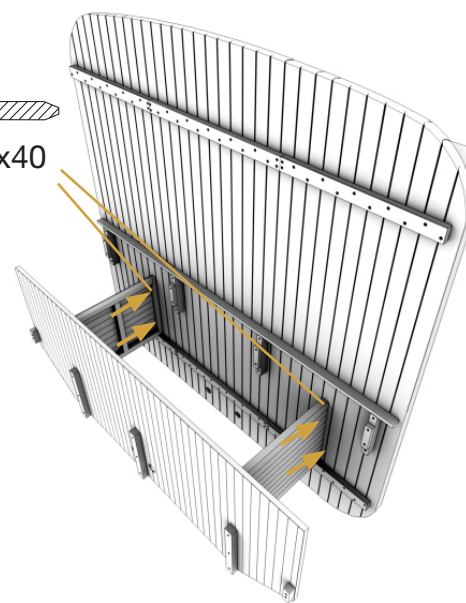
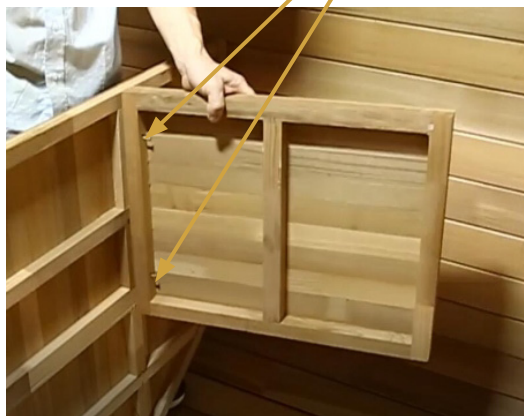
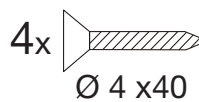
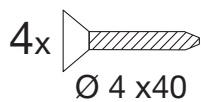
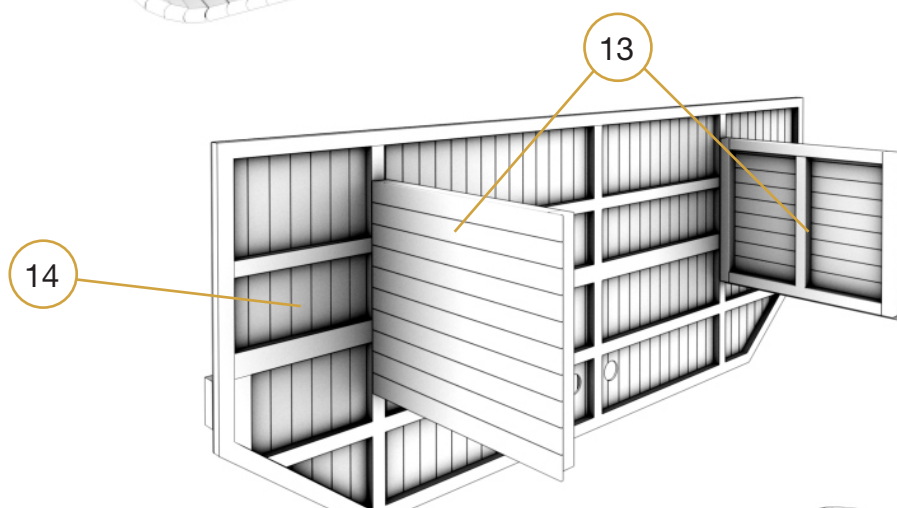

ES

Ensamblaje

Etapa 11:

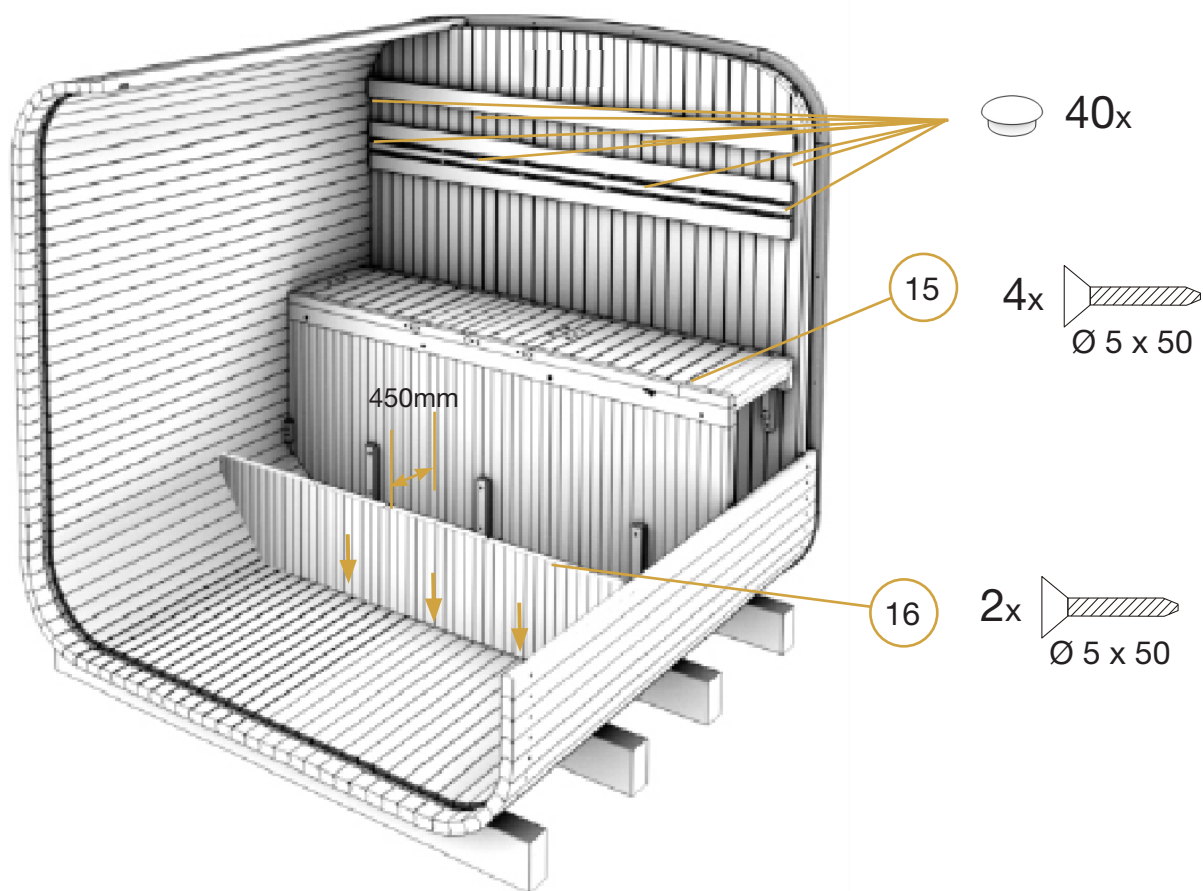

Etapa 12:

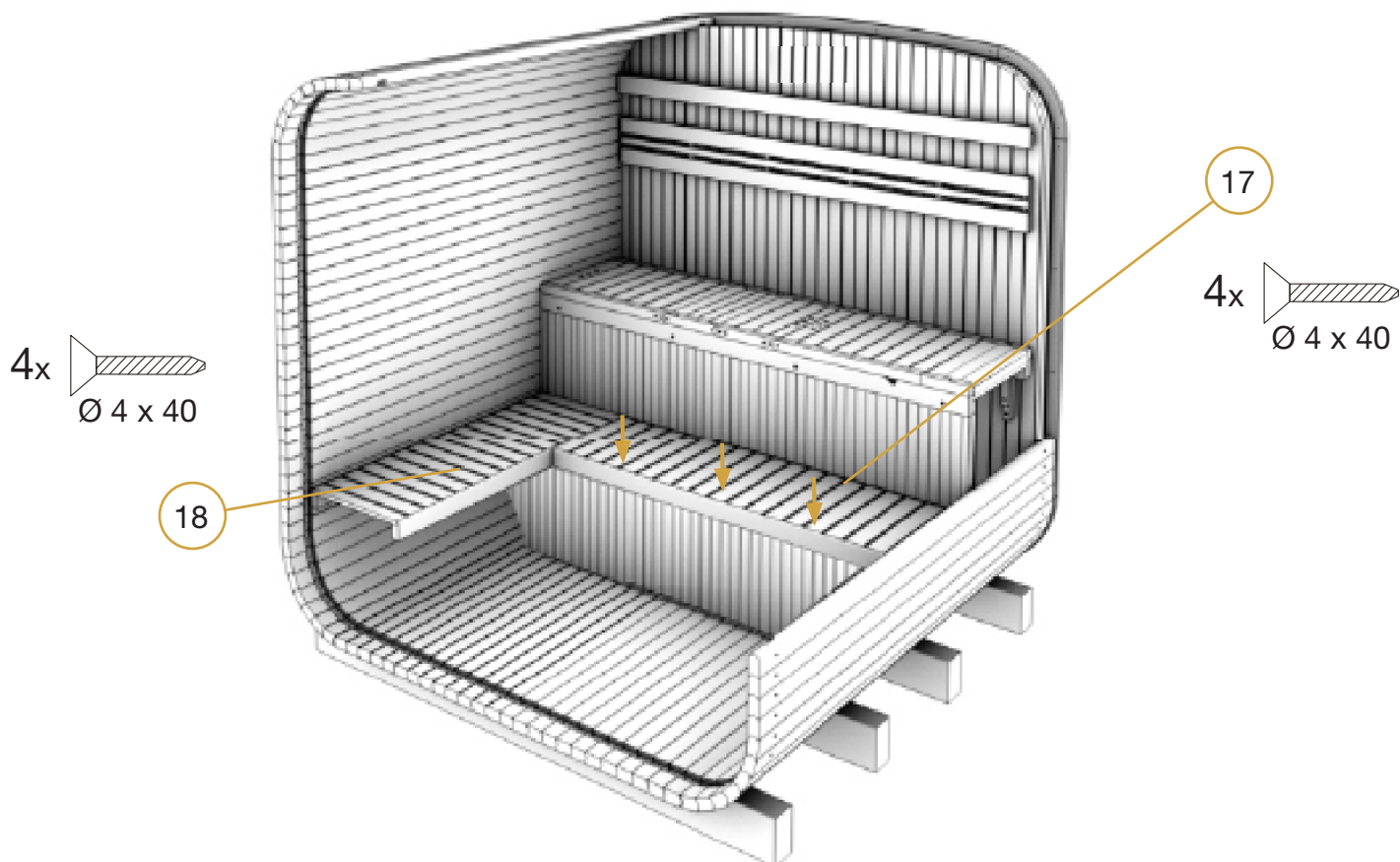

Ensamblaje

Etapa 13:

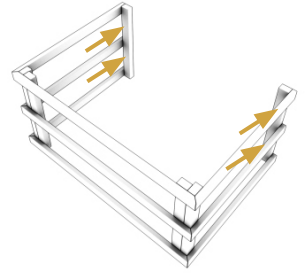
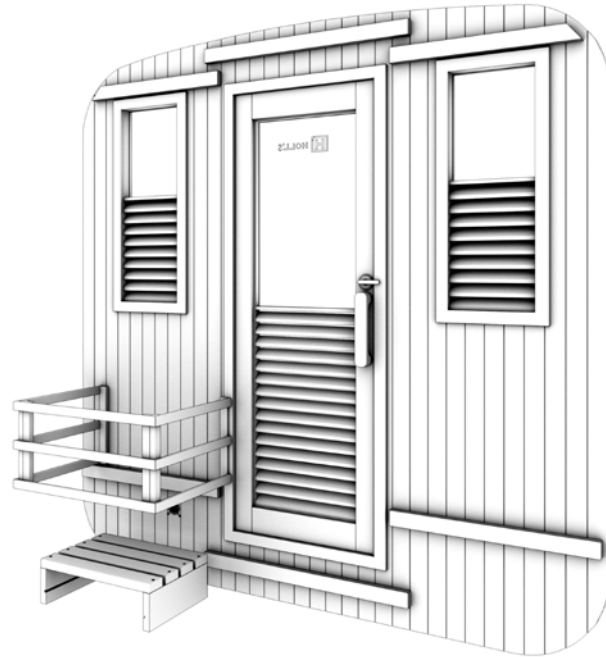

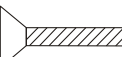
2x 
Ø 5 x 50

19

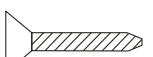
8x 
Ø 4 x 40

20

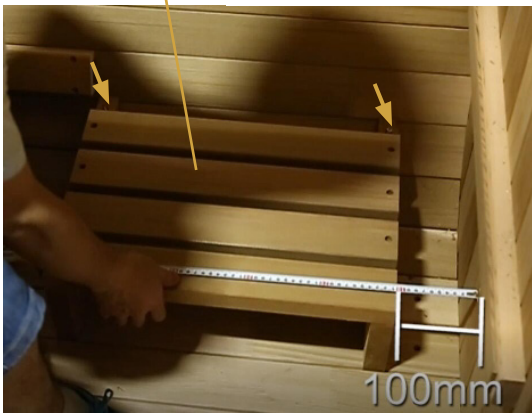

Etapa 14:

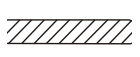

2x 
Ø 6 x 70

21

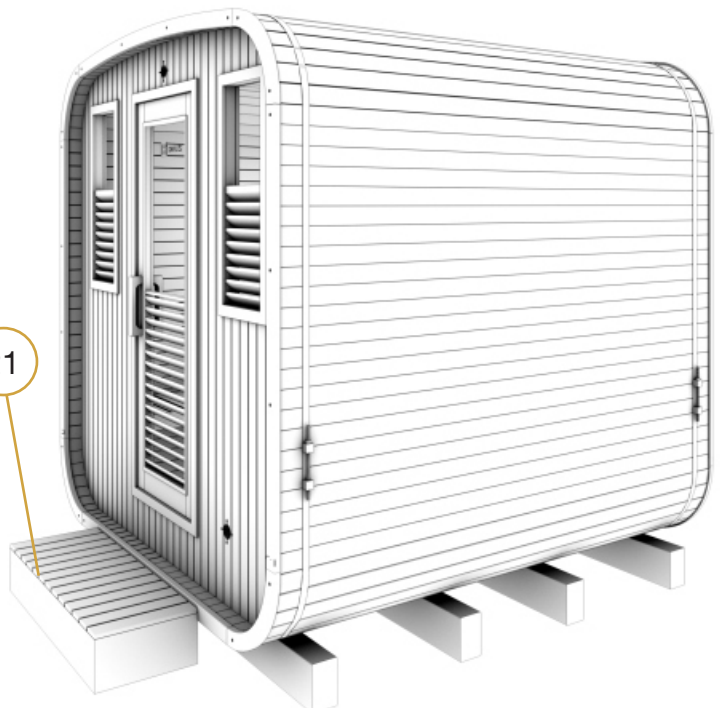

Ensamblaje

ATENCIÓN:

El techo es esencial para garantizar la estanqueidad de la sauna, debe adaptarse de acuerdo con el entorno.

Etapa 15:

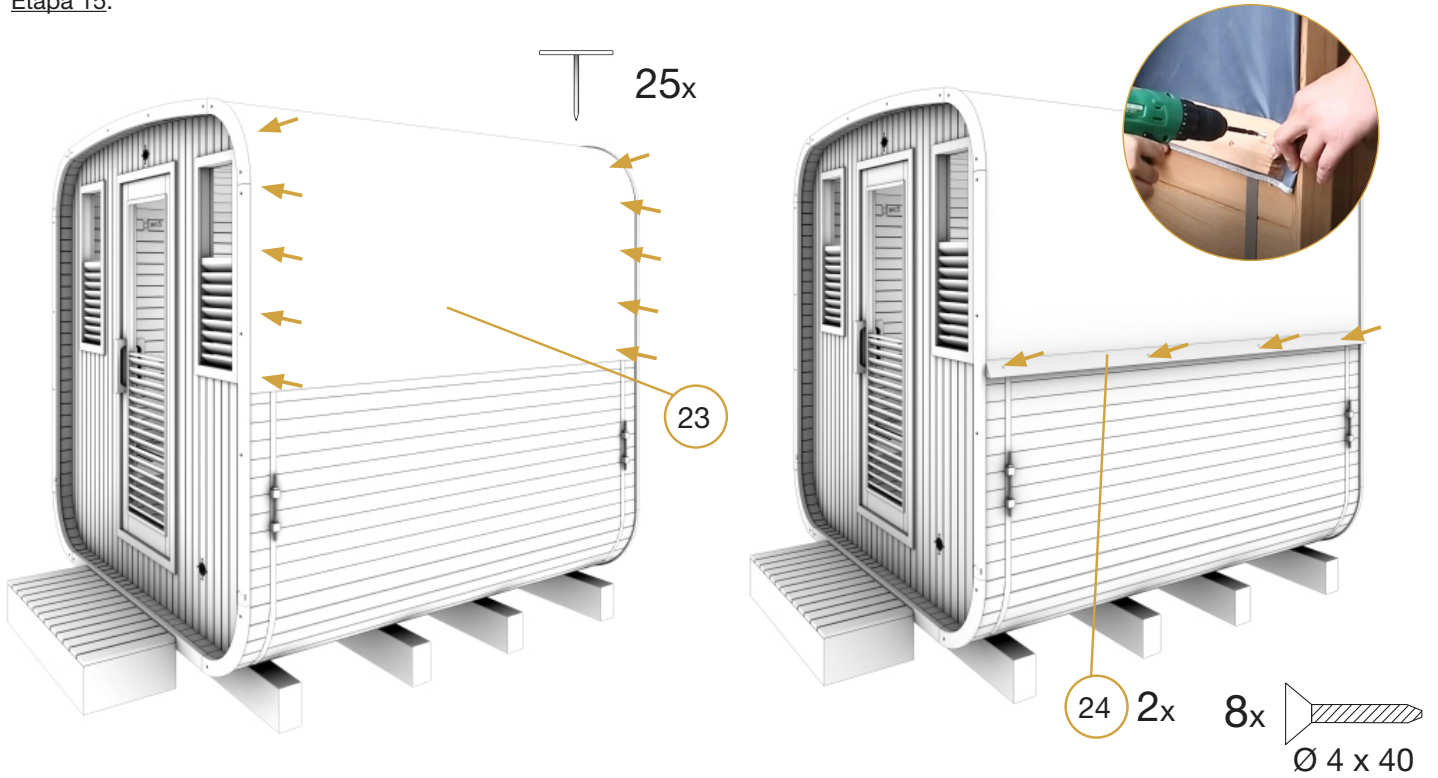

Etapa 16:

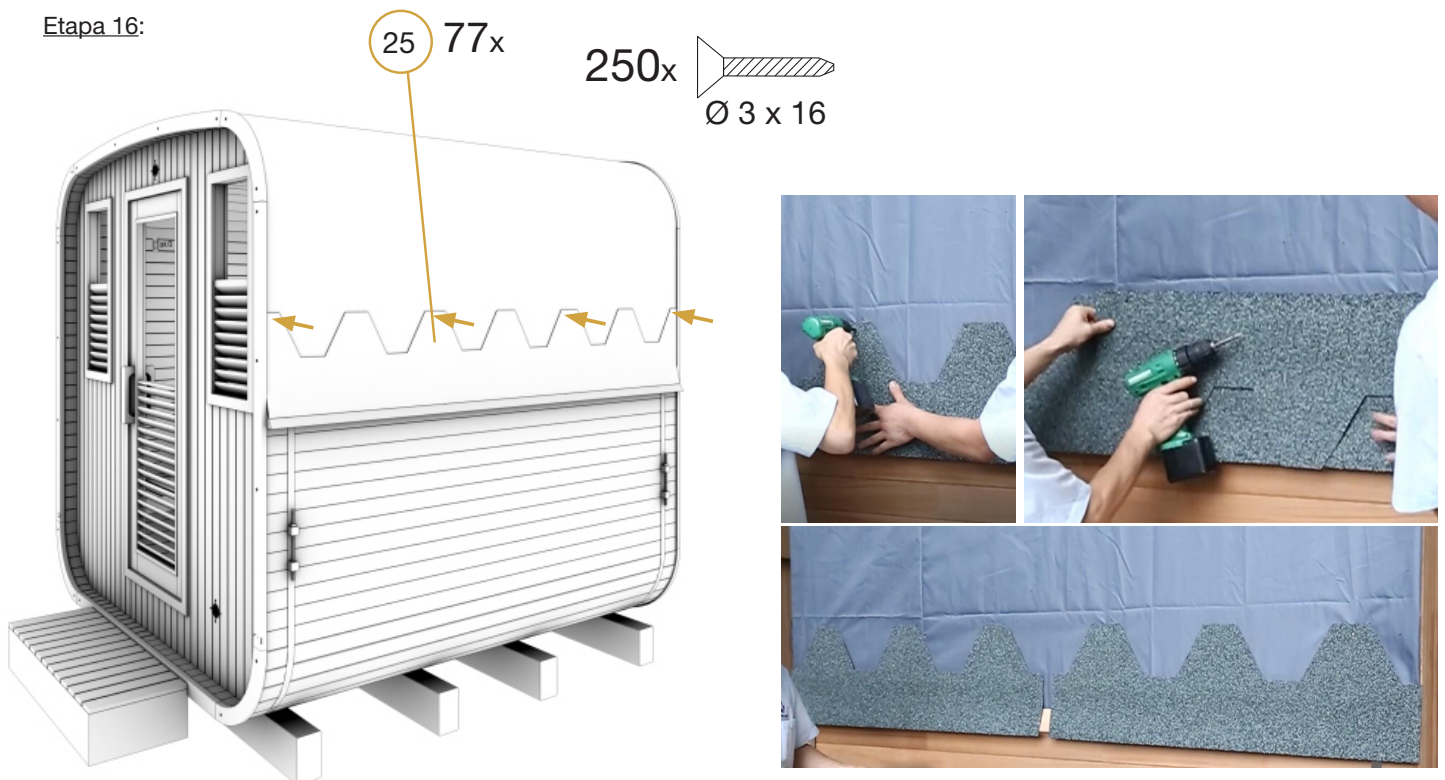

Ensamblaje

Etapa 17:

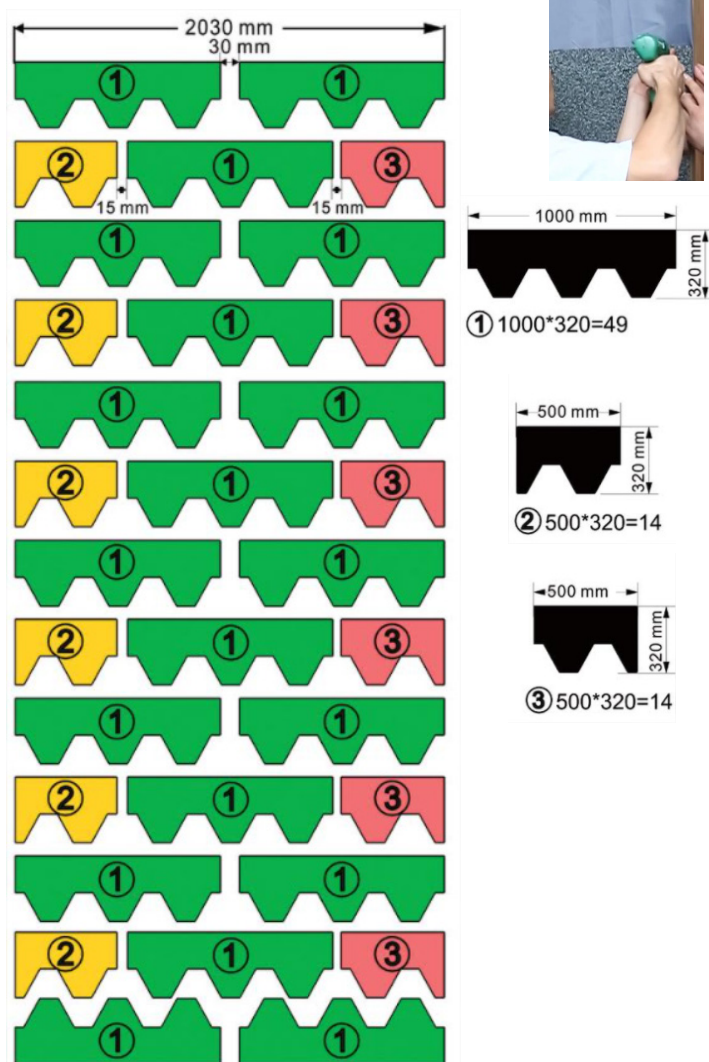
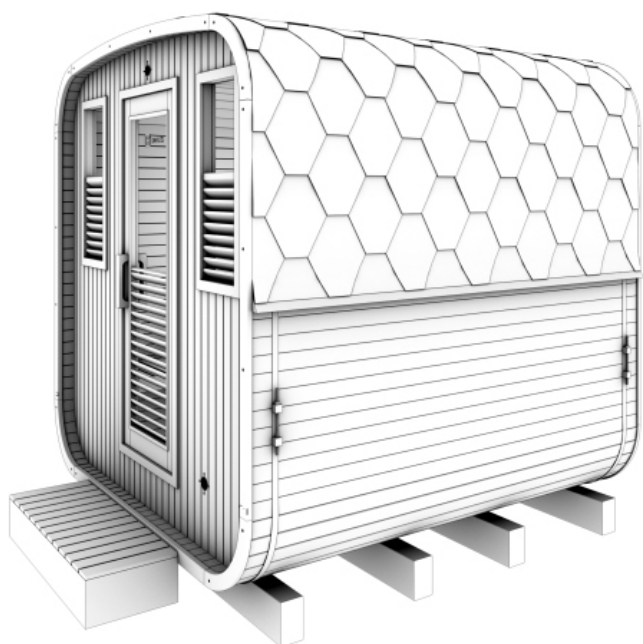

Etapa 18:

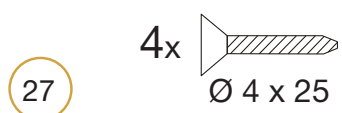

1: connect

2: fix



ES

Mantenimiento y cuidados

Mantenimiento

ATENCIÓN:

Antes de realizar cualquier operación, desenchufe el cable de alimentación de la cabina.

Problemas identificados	Posibles motivos	Soluciones
El calentador eléctrico no emite calor.	El cable de alimentación está desconectado.	Compruebe que el cable de alimentación está conectado.
	Se ha cortado el suministro eléctrico general.	Compruebe el funcionamiento adecuado del cuadro eléctrico y de la toma de pared.
	El calentador está en modo de seguridad por recalentamiento.	Consulte el manual del calentador eléctrico.
La luminaria de la sauna no funciona.	El cable de alimentación de la cinta lámpara no está bien conectado.	Conecte el cable alimentación.
	La cinta lámpara es defectuosa.	Contacte con su distribuidor.

Cuidados

1. Desconecte la sauna.
2. Utilice un aspirador para eliminar todo el polvo de las hendiduras de la madera.
3. Limpie la cabina con un trapo de algodón húmedo. En caso necesario, utilice una pizca de jabón. Aclárela con un trapo húmedo.
4. Limpiar el cristal con un limpiacristales y un paño suave.
5. Mantenga el exterior de la sauna cada 2 años con un producto adecuado.
6. En caso de fuertes lluvias pueden aparecer oreoles en el interior de la sauna, esto no es una fuga por capilaridad.

ATENCIÓN:

La madera debe tratarse con un producto protector solo en el exterior de la sauna.

No se debe aplicar tratamiento dentro de la sauna.

No utilice benceno, alcohol, productos químicos ni productos de limpieza agresivos en la sauna, ya que estos pueden dañar la madera y la capa de protección que la recubre. No pulverice agua sobre la sauna.

Garantía

El conjunto de los elementos que componen el sauna dispone de una garantía de 2 años y 4 años para piezas de madera. La fecha de entrada en vigor de la garantía se corresponde con la fecha de envío (es decir, la fecha de emisión de la factura). La garantía no cubre los siguientes casos:

- Fallos en el funcionamiento o daños provocados por la instalación, el uso o la reparación no conforme con las instrucciones de seguridad.
- Fallos en el funcionamiento o daños provocados por un uso indebido del aparato.
- Daños provocados por negligencia, por un accidente o por un caso de fuerza mayor (una tormenta o la intemperie).
- Fallos en el funcionamiento o daños provocados por el uso de accesorios no autorizados.
- Mal funcionamiento o daño resultante de la no instalación de un techo a prueba de agua.
- Mal funcionamiento o daño resultante de la falta de mantenimiento de la parte exterior de la sauna.

La garantía no cubre los gastos de envío incurridos por el transporte de la cabina o uno de sus componentes a nuestro taller de reparación. De acuerdo con la garantía, en caso de avería, se cambiarán las piezas que nuestros técnicos hayan considerado defectuosas. Uno de nuestros técnicos proporcionará la información y las instrucciones necesarias para su instalación. Holl's no se hace responsable de los gastos incurridos por la contratación de mano de obra externa.



PRECAUCIÓN

No le devuelva el producto a la tienda

Póngase en contacto con su centro de servicio posventa local sobre www.holls.fr o **POOLSTAR**
960 Avenue Olivier Perroy, 13790 ROUSSET - FRANCE

LED Controller

	Caja de control LED	Control remoto
Temperatura de funcionamiento	-30 ° C / 60 ° C	-30 ° C / 60 ° C
Tensión	CD5V / 12 / 24V DC	2 pilas NO7 - 3V
salida	Salida abierta de drenaje N-MOS de 3 canales	-
El consumo de energía	0.5W	0.09mW
Salida	6A 3 canales: 18A 6A	
Dimensiones de la caja	83 x 79 x 33 cm	

Fonctions :

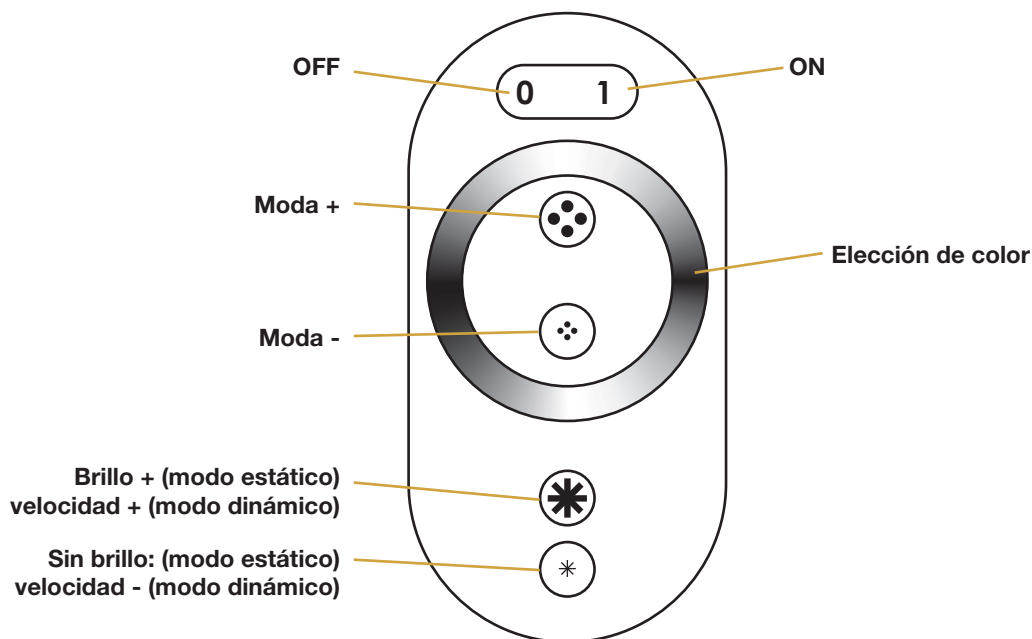

Mode	Encendiendo	comments		
1	rojo estático (R)	Brillo ajustable	10	Transición de 3 colores (G / B / R)
2	verde estático (G)		11	Transición de 5 colores (G / B / P / R / Y)
3	azul estático (B)		12	Transición de 7 colores (G / B / Y / P / LB / W / R)
4	amarillo estático (Y)		13	Onda de 5 colores (R / Y / G / B / W)
5	púrpura estática (P)		14	Flash de 3 colores (R / G / B)
6	azul claro estático (LB)		15	7 colores flash (W / R / G / B / Y / P / LB)
7	blanco estático (W)		16	3-color dynamic flash (R / G / B)
8	Salta entre 3 colores (G / B / R)	Velocidad y brillo ajustables.	17	Flash dinámico de 7 colores. (R / G / B / Y / P / LB / W)
9	Salta entre 7 colores (R / G / B / Y / P / LB / W)		18	Automático

Velocidad y brillo ajustables.

A large white rectangular area containing 21 horizontal gold lines, spaced evenly for writing.

Avvertenze

Leggere attentamente questo manuale prima di utilizzare la sauna per la prima volta.

Si raccomanda di conservare con cura il presente manuale per eventuali consultazioni future.

- Il legno è un elemento vivente, per mantenere il suo aspetto originale, è importante trattare l'esterno del legno dall'umidità. Utilizzare un saturatore solo all'esterno della sauna.

Installare la sauna su un pavimento perfettamente piatto.
- La sauna deve essere posizionata in una zona asciutta. Non utilizzarla in prossimità di una zona umida (vasca da bagno, pavimento umido, piscina).
- Non utilizzare prodotti detergenti liquidi. D Scollegare la sauna prima di procedere alla pulizia e utilizzare un panno umido (vedere capitolo manutenzione).
- Proteggere il cavo elettrico della sauna per evitare che venga calpestato o schiacciato.
- Prima di procedere alla sostituzione di alcuni pezzi, assicurarsi che siano quelli indicati dal fabbricante o che abbiano caratteristiche simili ai pezzi di ricambio originali. Una sostituzione non corretta può generare un incendio, un corto circuito o danneggiare la sauna. Si raccomanda vivamente di rivolgersi a un tecnico qualificato.
- Per evitare rischi di scottature o di scariche elettriche, non utilizzare alcuno strumento metallico.
- Non fare entrare animali all'interno della sauna.
- Non lasciare la sauna accesa priva di sorveglianza.
- Non lasciare la sauna accesa per più di 3 consecutive per evitare di deteriorare prematuramente i circuiti e gli impianti. Dopo 3 ore di utilizzo continuativo, si raccomanda di spegnere la sauna per almeno un'ora.
- Si raccomanda di non installare alcun sistema di chiusura sulla porta della sauna.
- Verificare la conformità del vostro impianto elettrico prima di procedere al collegamento elettrico della vostra sauna.

***Annotare e conservare i numeri di serie della sauna e la fattura di acquisto.
Potrebbero esserti richiesti durante la tua richiesta di servizio post-ven-
dita.***

Sicurezza

ATTENZIONE:

Si prega di leggere attentamente le istruzioni di sicurezza prima di installare ed utilizzare la vostra cabina sauna. Tali istruzioni sono fondamentali per la vostra sicurezza, si prega di rispettarle in maniera scrupolosa.

Si prega di fare attenzione ad ipertermia, insolazioni e colpi di calore che possono essere provocati o aggravati dal mancato rispetto delle istruzioni di sicurezza. I sintomi sono febbre, accelerazione del battito cardiaco, vertigini, svenimento, letargia, intorpidimento del corpo o di una parte del corpo.

Gli effetti: Mancata percezione del calore, mancata considerazione del rischio imminente, perdita di conoscenza.

La sauna non deve essere utilizzata da:

- Bambini inferiori ai 6 anni.
- Persone soggette a gravi reazioni quando esposte ai raggi del sole.
- Persone anziane o invalide.
- Persone con patologie come malattie cardiache, ipertensione / ipotensione, problema di circolazione sanguigna o diabete senza un preventivo controllo medico.
- Donne incinte. Una temperatura eccessiva può essere pericolosa per il feto.
- Persone che soffrono di disidratazione, ferite aperte, patologie oculari, scottature, colpi di sole.

I bambini tra 6 e 16 anni possono utilizzare la sauna a condizione che siano sotto il costante controllo di un adulto responsabile e che la temperatura non superi i 60°C (140°F).

In caso di problema di salute, di assunzione di farmaci, di ferite muscolari o ai legamenti, non utilizzare la sauna senza aver consultato ed aver ricevuto il consenso preventivo di un medico.

In caso di utilizzo di impianti chirurgici, non utilizzare la sauna senza aver consultato ed aver ricevuto il consenso preventivo di un medico.

Non utilizzare la sauna dopo uno sforzo intenso. Attendere 30 minuti affinché l'organismo possa raffreddarsi.

Non fare una seduta di sauna di oltre 40 minuti.

Non consumare alcol o droga prima o durante la seduta.

Non addormentarsi nella sauna quando questa è in funzione.

Per evitare rischi di surriscaldamento, collegare la vostra sauna ad una presa di corrente sufficientemente potente e non collegare altri apparecchi elettrici alla stessa presa a muro.

Per evitare ogni rischio di elettrocuzione o di deterioramento della sauna, non utilizzare la sauna:

- In caso di temporale.
- Se il cavo elettrico è danneggiato, dovrà essere sostituito da personale tecnico qualificato.
- Se il cavo elettrico è in surriscaldamento, dovrà essere controllato da personale tecnico qualificato.
- Nel caso in cui sia necessario sostituire una lampadina, attendere che la sauna sia spenta e che si sia raffreddata.

Si raccomanda di asciugarsi le mani prima di collegare o scollegare la corrente. Si raccomanda di non compiere alcuna operazione con le mani o i piedi bagnati.

Si raccomanda di non accendere e spegnere freneticamente la corrente o il sistema di riscaldamento, in quanto questo potrebbe causare danni al sistema elettrico.

Ogni eventuale tentativo di riparazione non autorizzato annullerà la garanzia del fabbricante.

Si raccomanda di non accatastare o stoccare oggetti all'interno o sulla sauna.

Non depositare materiale infiammabile o agenti chimici vicino alla sauna.



Descrizione della sauna

Caratteristiche tecniche

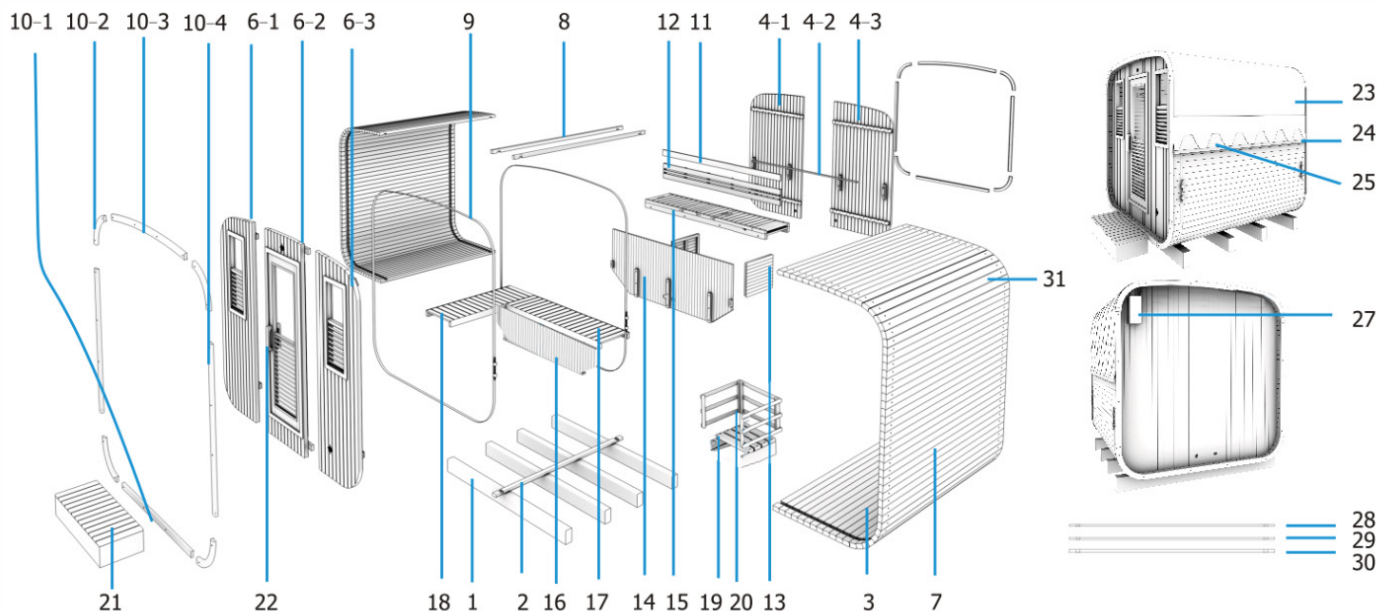
Modello	HL-B200E
Legno	Abete canadese
Voltaggio	230 V - 50 Hz (esclusa la stufa)

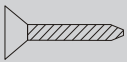

N°	QTÀ	Nome
1	4	Culle a botte 1980x70x150
2	1	Speciale stecca inferiore (convessa su entrambi i lati)
3	16	speciali doghe laterali senza fori
3-2	2	speciali doghe laterali con fori
4-1	1	Sezione della parete posteriore (sinistra)
4-2	1	Barra di collegamento a parete posteriore
4-3	1	Sezione della parete posteriore (destra)
6-1	1	Sezione della parete frontale (finestra a sinistra)
6-2	1	Sezione della parete frontale (porta a vetri)
6-3	1	Sezione della parete frontale (finestra a destra)
7	52	Stecca sauna standard 1998x85x38mm
8	2	Lamella superiore speciale 76 * 38mm (convessa su un lato)
9	2	Cinturini per sauna in acciaio inossidabile
10-1	2	Grondaia decorativa (inferiore)
10-2	4	Grondaia decorativa (angolo)
10-3	2	Grondaia decorativa (superiore)
10-4	4	Grondaia decorativa (laterale)
11	1	Fascio di luce a LED
12	1	Schienale
13	2	Pannello superiore del banco (laterale)
14	1	Pannello superiore del banco (anteriore)
15	1	Pannello superiore del banco (pieghevole)
16	1	Staffa da banco bassa
17	1	Panca bassa

	Dimensioni	QTÀ
	Ø 5 x 50	32
	Ø 4 x 40	188
	Ø 4 x 25	8
	Ø 3 x 18	6
	Ø 3 x 16	250
	Ø 6 x 75	2
	Ø 4 x 12	4
	Chiave a brugola 1	1
	Chiave a brugola 2	1

Installazione

18	1	Panca laterale
19	1	Staffa supporto stufa sauna (con vassoio dell'acqua)
20	1	Griglia per stufa sauna (tre parti per set)
21	1	gradino d'ingresso
22	1	Maniglia
23	1	Cappotto da pioggia (grigio)
24	2	Naso d'acqua
25	100	Asfalto ghiaia (grigio)
26	1	Copertura del filo
27	1	Scatola di controllo
28	1	Stecca di riempimento superiore (10 mm)
29	1	Stecca di riempimento superiore (15mm)
30	1	Stecca di riempimento superiore (20mm)
31	16	Listello angolare speciale (70x38mm) con foro
31-2	16	Listello angolare speciale (70x38mm) senza foro

Si raccomanda di leggere attentamente le istruzioni di montaggio prima di iniziare l'assemblaggio.

Sceita dell'ubicazione

Le saune Holl's sono progettate per essere installate unicamente in spazi esterno.

Scegliere uno spazio:

- In luogo asciutto, su un pavimento piatto e stabile, in grado di sostenere il peso della sauna.
- L'altezza deve essere sufficiente per consentire di accedere al tetto e di realizzare i collegamenti elettrici ed eventuali interventi di manutenzione.
- Al riparo da ogni fonte d'acqua, di fiamma o di sostanze infiammabili.

Per l'installazione della sauna esterna è necessaria una soletta in cemento perfettamente piana, livellata e asciutta, altrimenti il corretto montaggio potrebbe essere compromesso.

Consigli pratici

- Si prega di notare che il montaggio della sauna richiede da 2 a 3 persone adulte.
- Prima di procedere al montaggio, identificare chiaramente ogni pannello.
- Durante il montaggio, posizionare il cavo di alimentazione della vostra sauna in modo che sia facilmente accessibile.
- Si prega di notare che vi sono delle differenze tra i vari modelli.
- Note that there are variations between the models.

ATTENZIONE:

Verificare i fori e il loro diametro per evitare di danneggiare il legno.

L'altezza minima richiesta per l'installazione è di 2020 mm

Attrezzi necessari

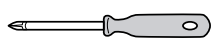

Cacciavite a croce



Metro



Sgabello



Matita



Taglierina

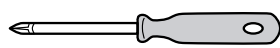

2 Chiave piatta
(19 mm)



Avvitatore
elettrico

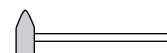

Mazzuolo



Trapano a spirale
in legno



Chiave a
brugola

Assemblaggio

Fasi di assemblaggio

Fase 1:

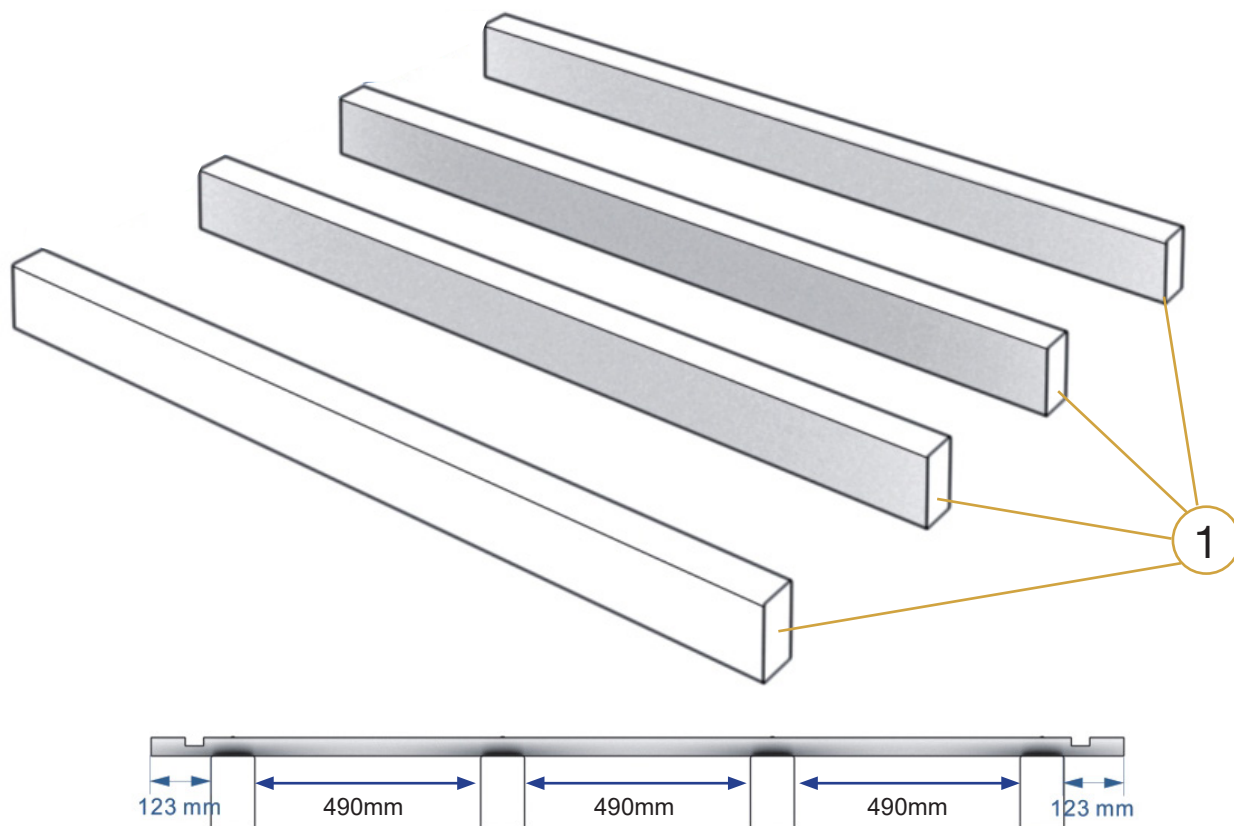

Fase 2:

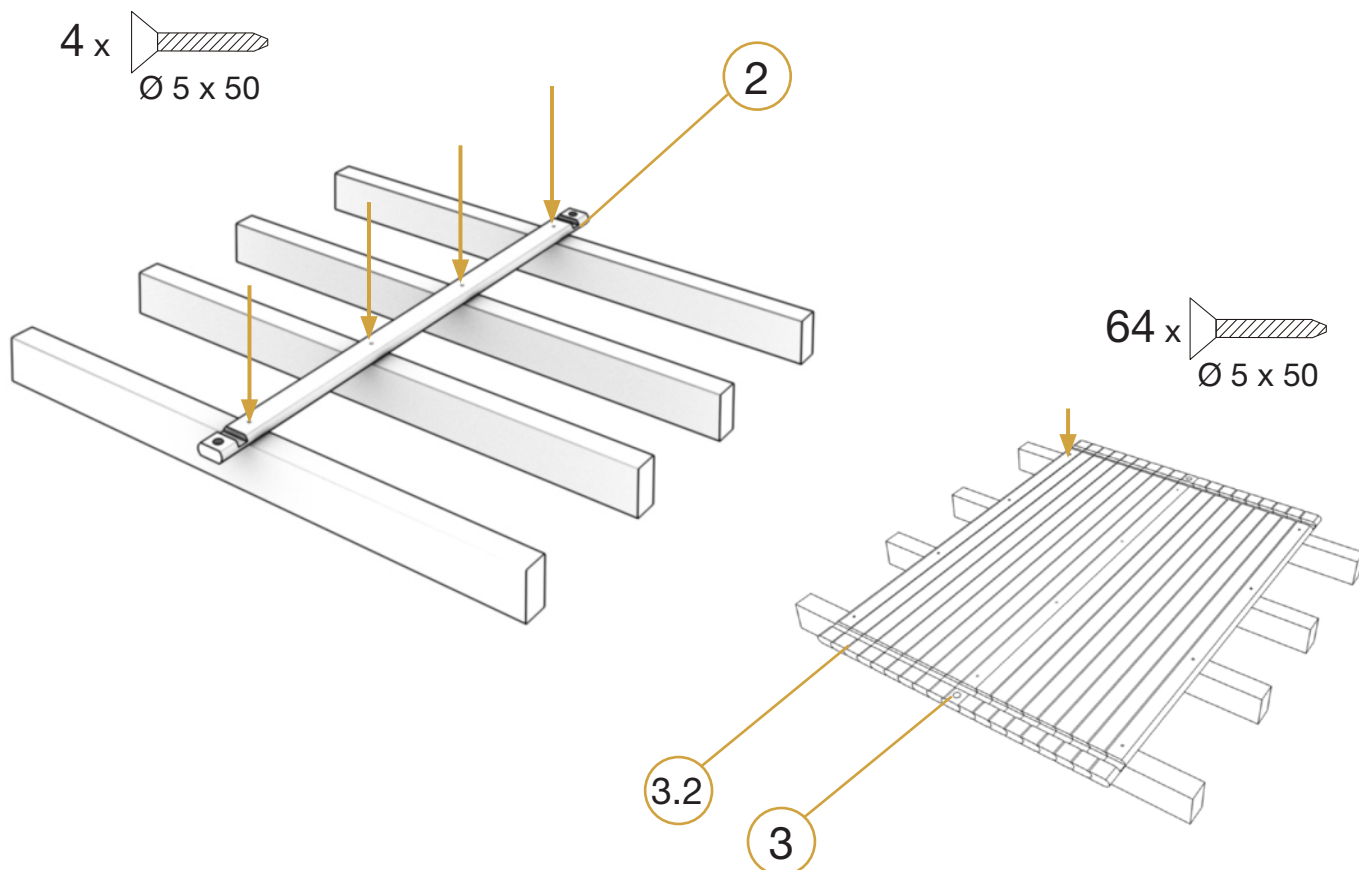

Assemblaggio

Fase 3:

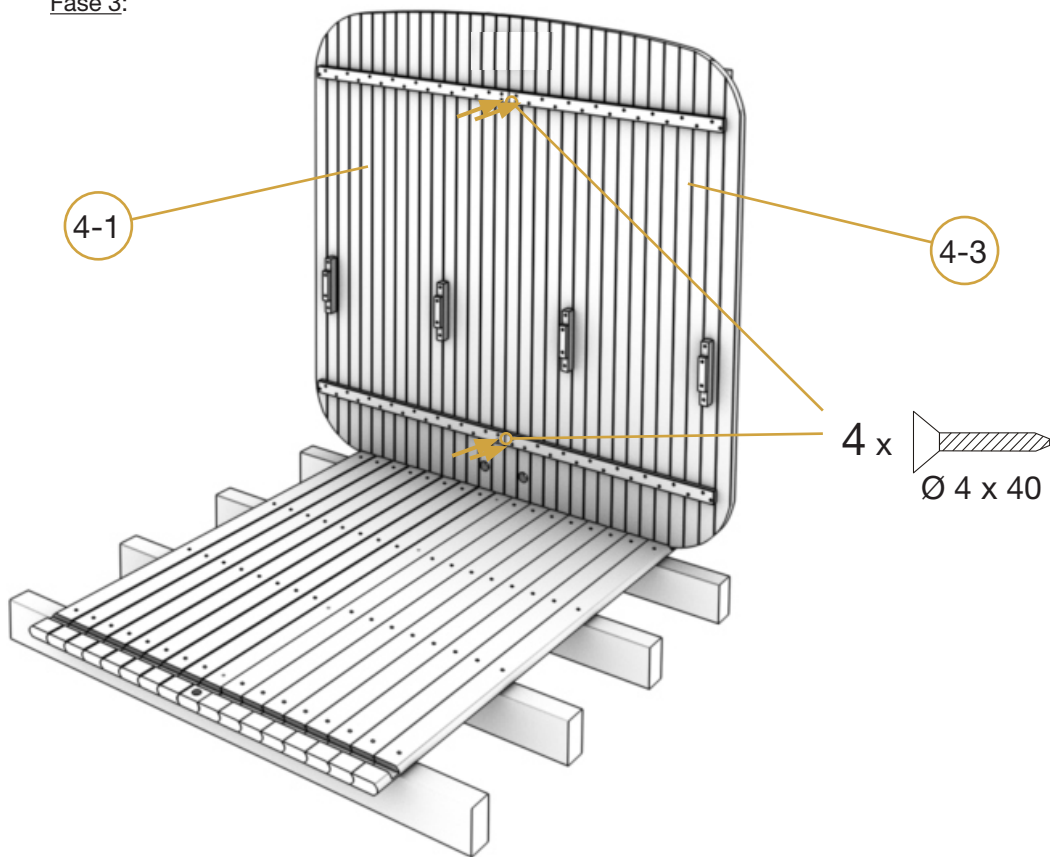

Fase 4:

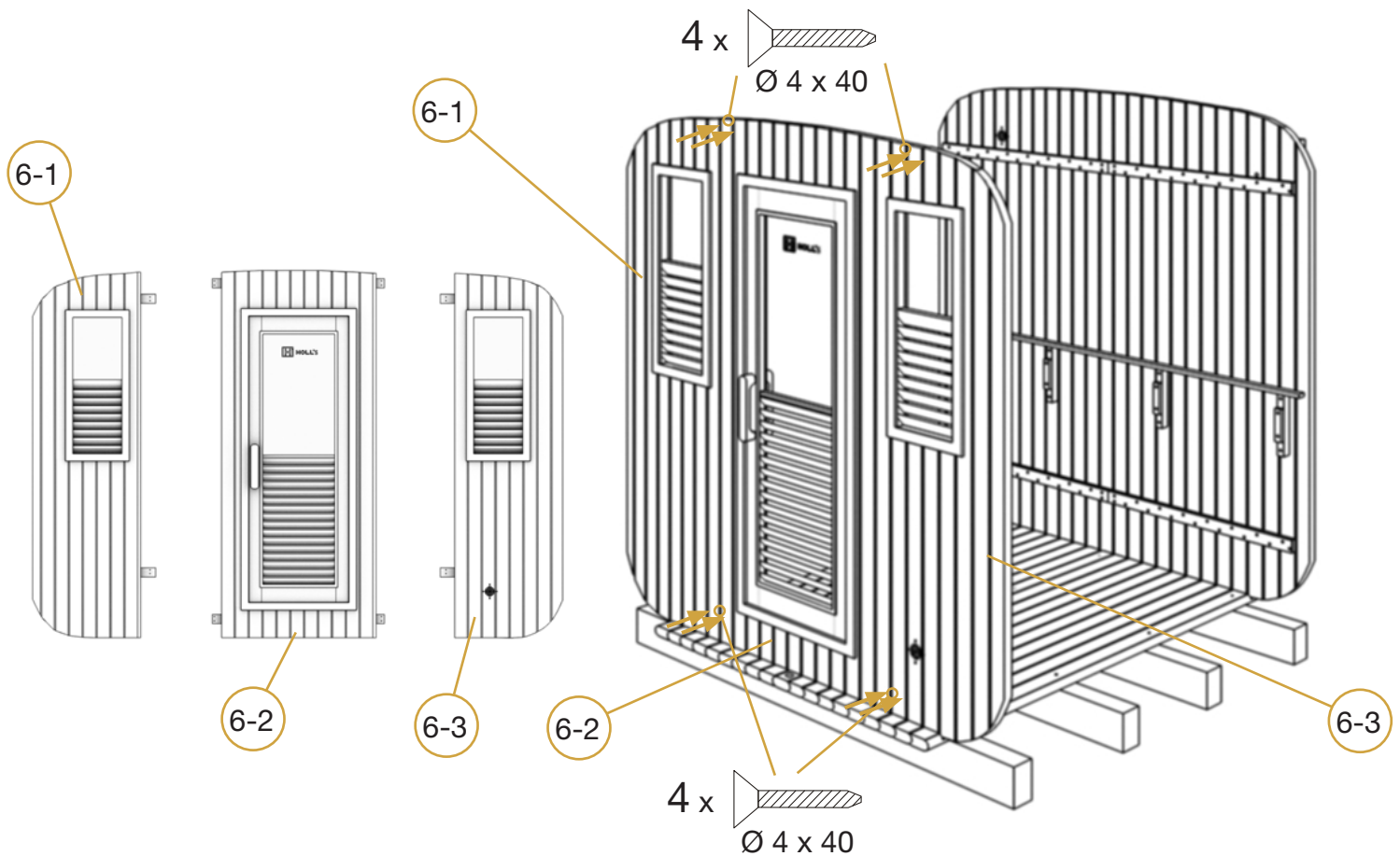

Assemblaggio

Fase 5:

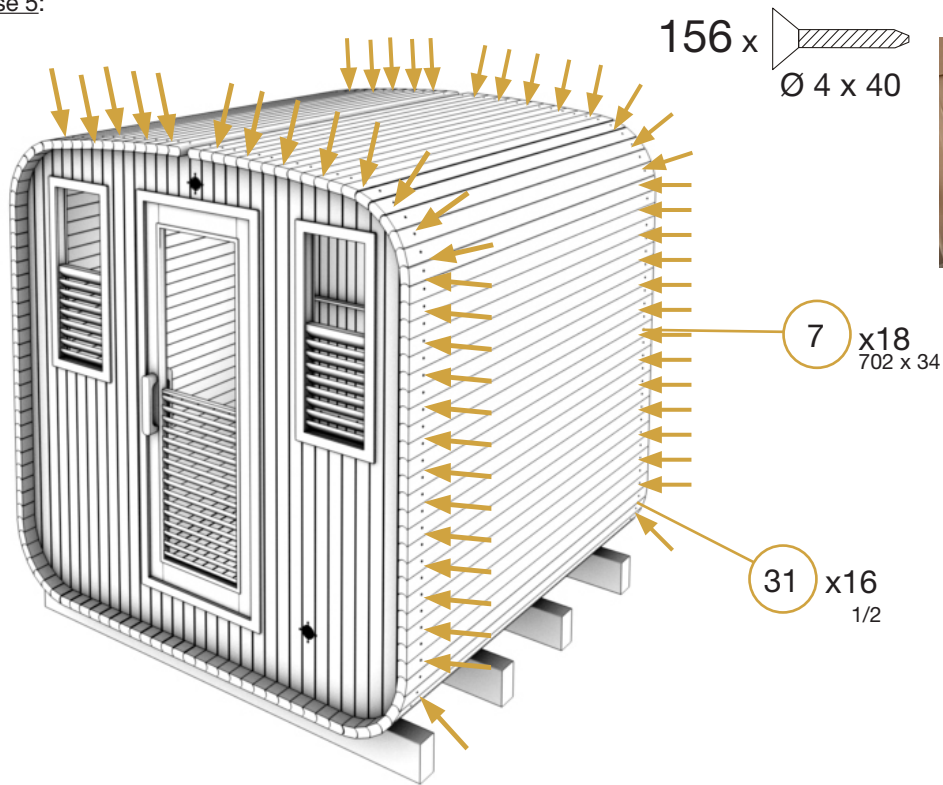

Fase 6:

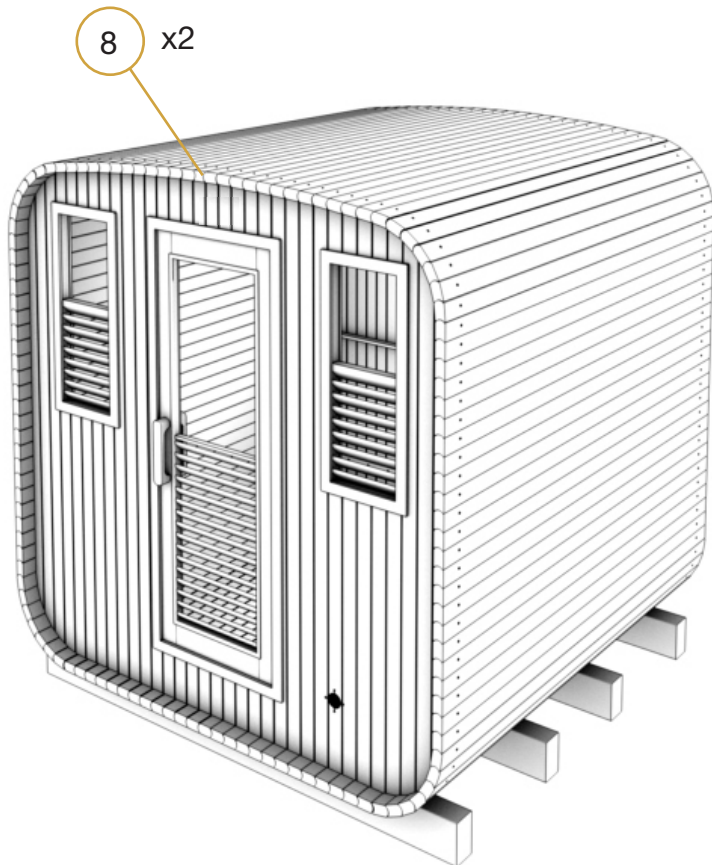

28 / 29 / 30

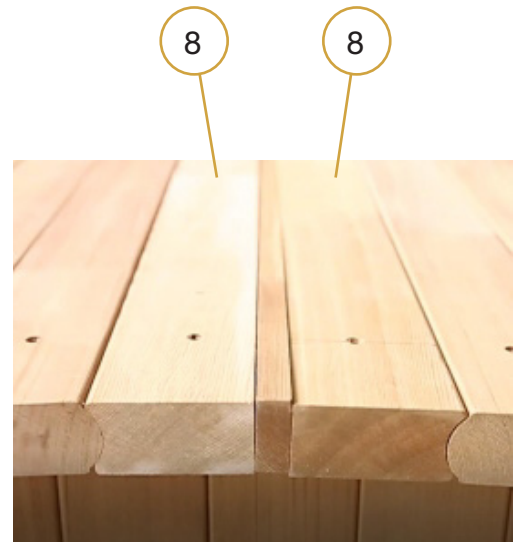

Assemblaggio

Fase 7:

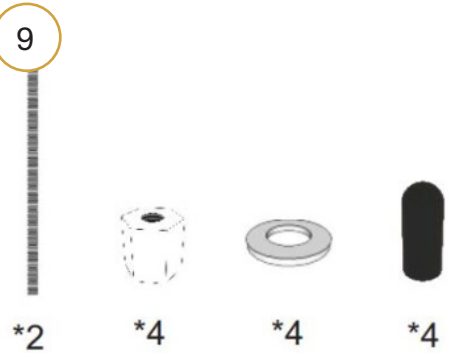
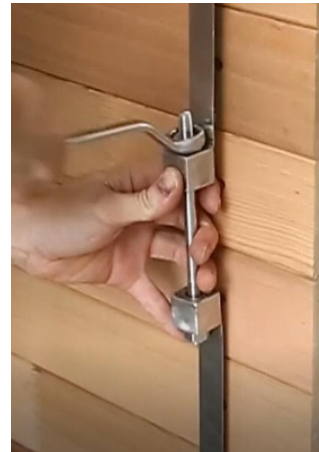

Fase 8:

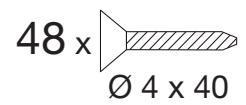
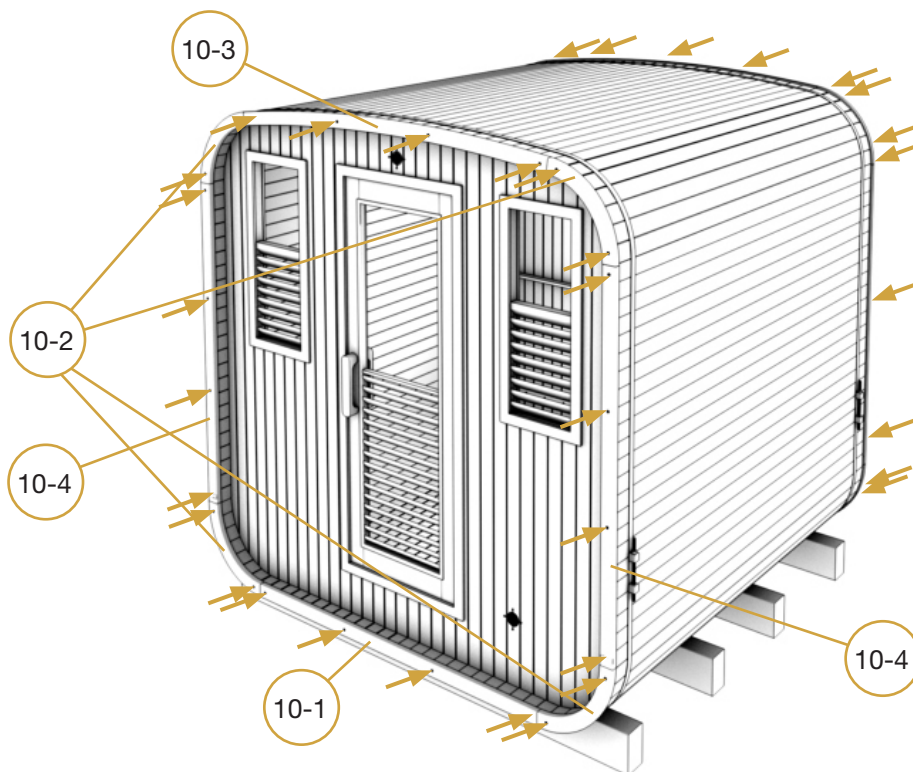

Assemblaggio

Fase 9:

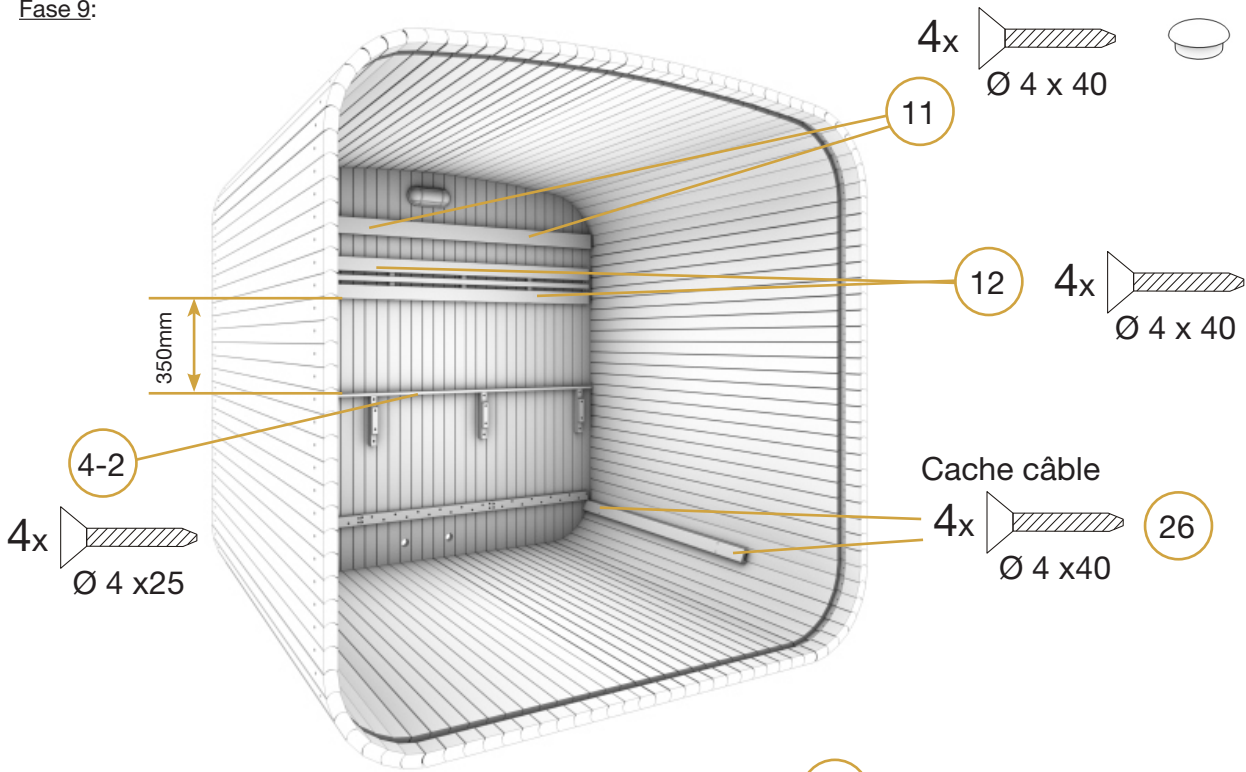

Fase 10:

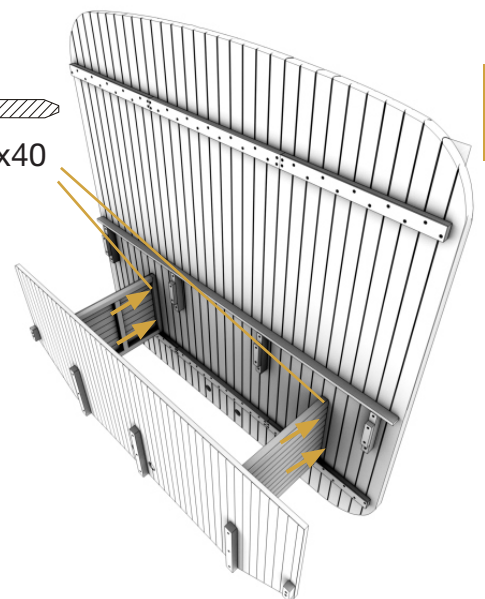
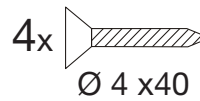
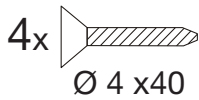
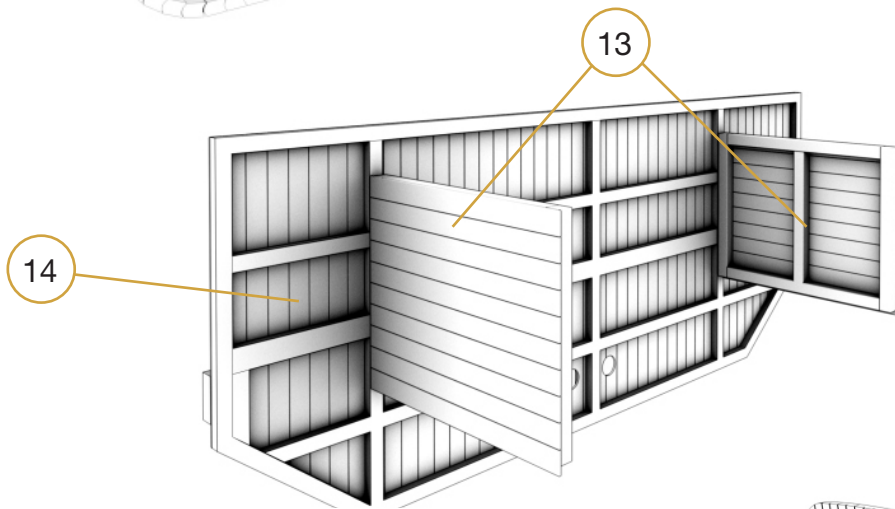

IT

Fase 11:

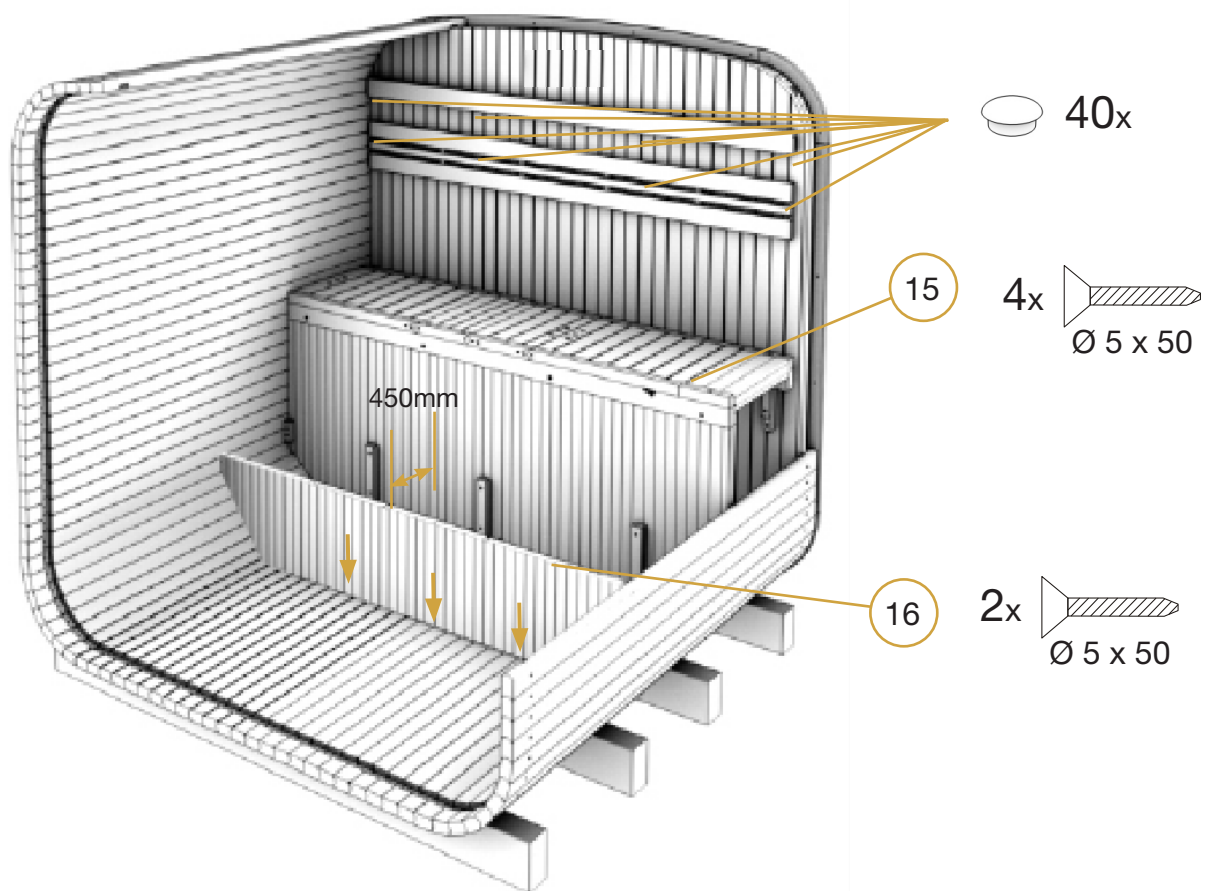

Fase 12:



Fase 13:

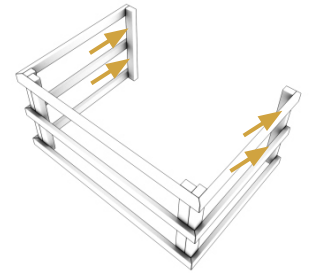

2x 
 Ø 5 x 50

19

8x 
 Ø 4 x 40

20

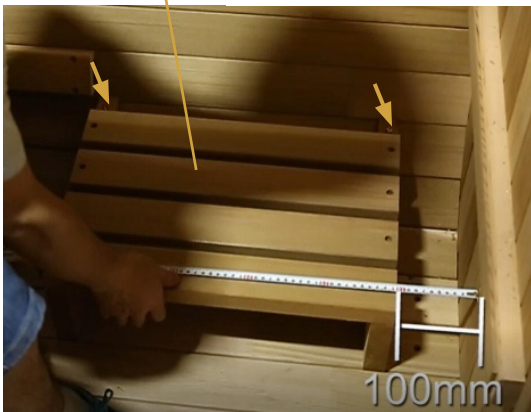

Fase 14:



2x 
 Ø 6 x 70

21

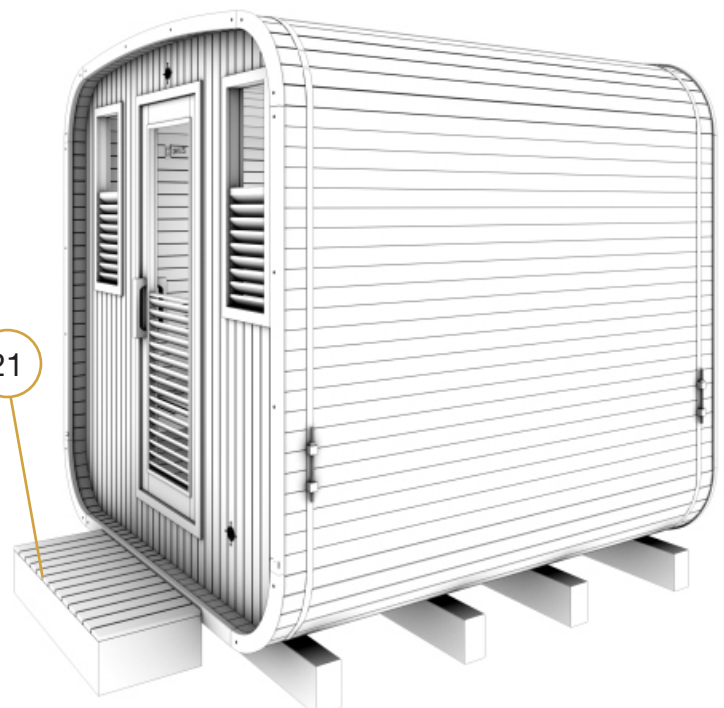

Assemblaggio

ATTENZIONE:

Il tetto è essenziale per garantire la tenuta stagna della sauna, deve essere adattato in base all'ambiente.

Fase 15:

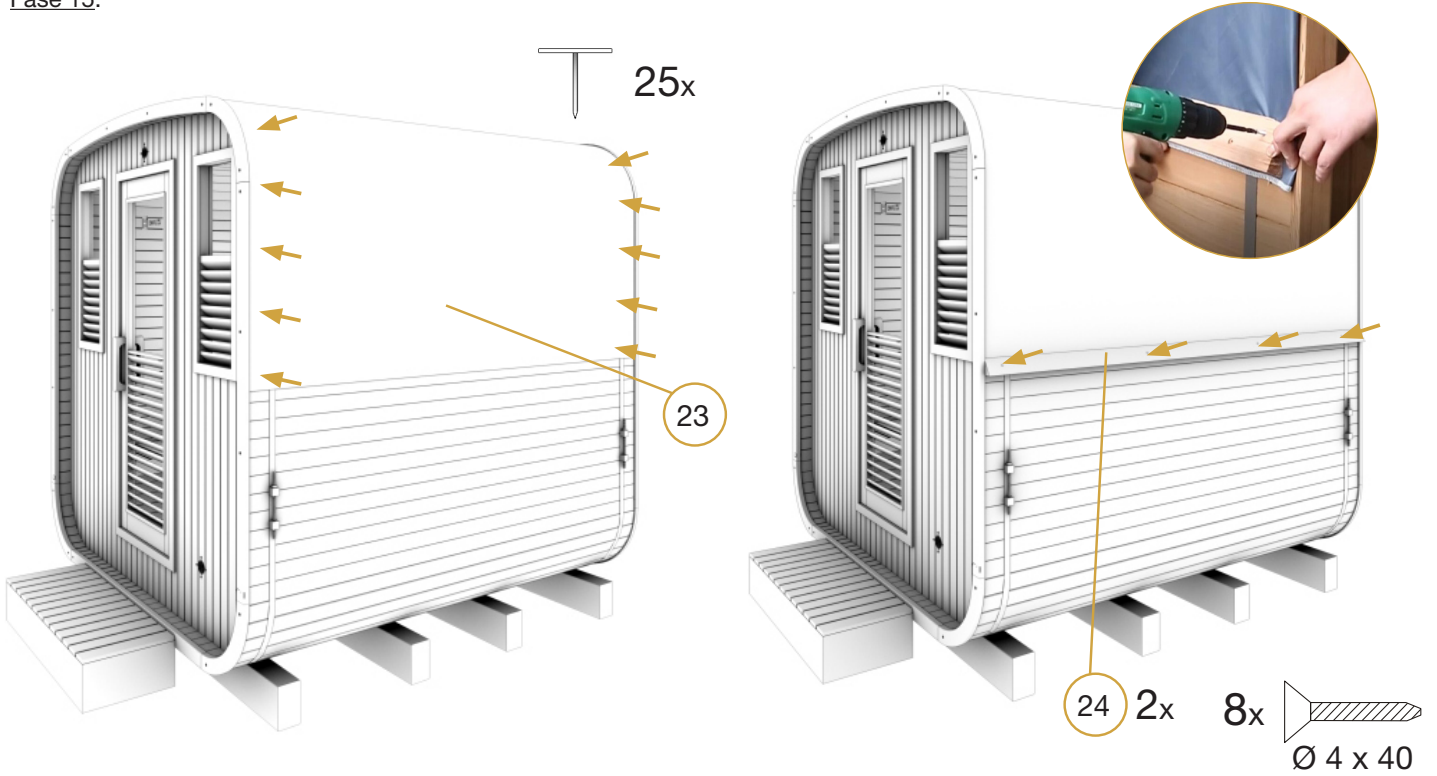

Fase 16:

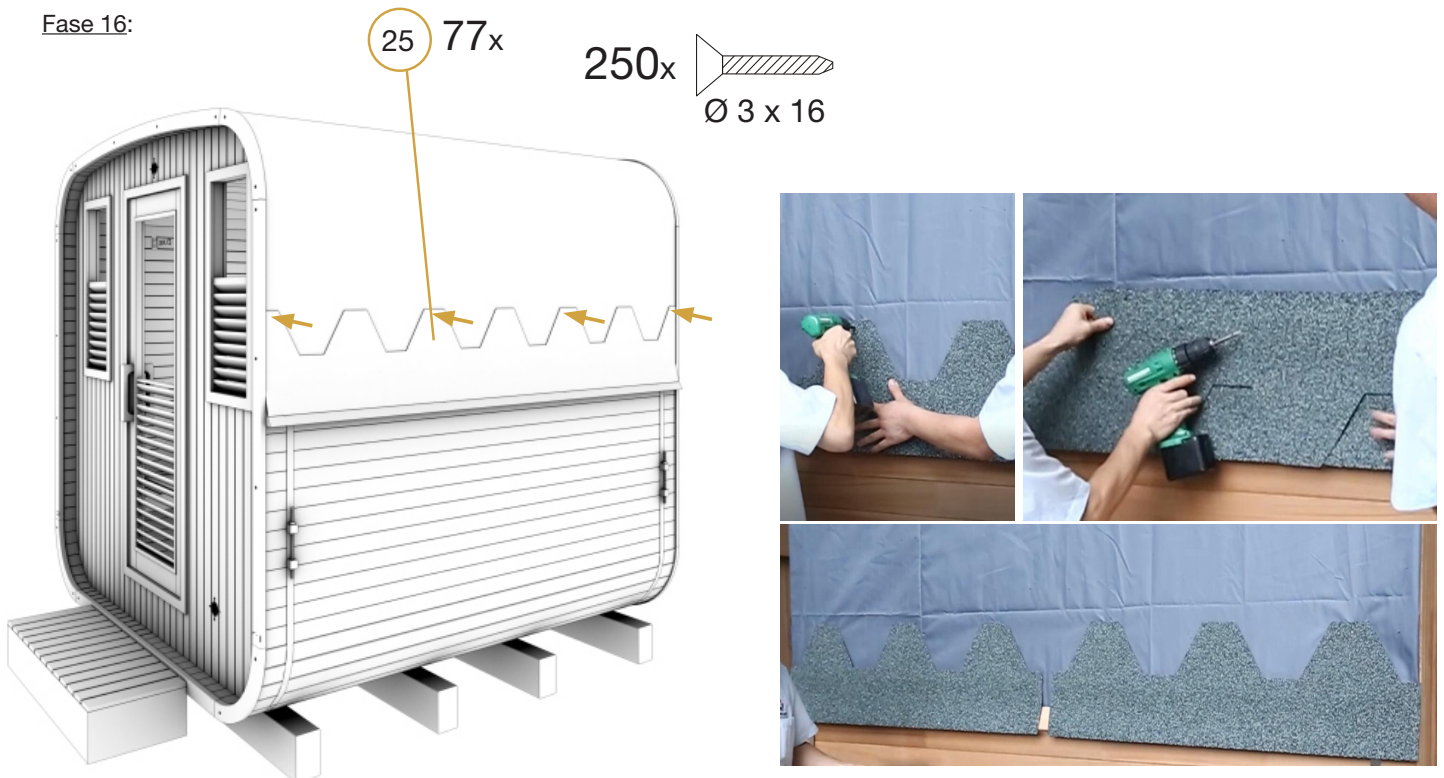

Manutenzione

Fase 17:

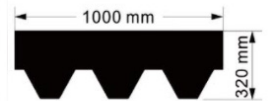
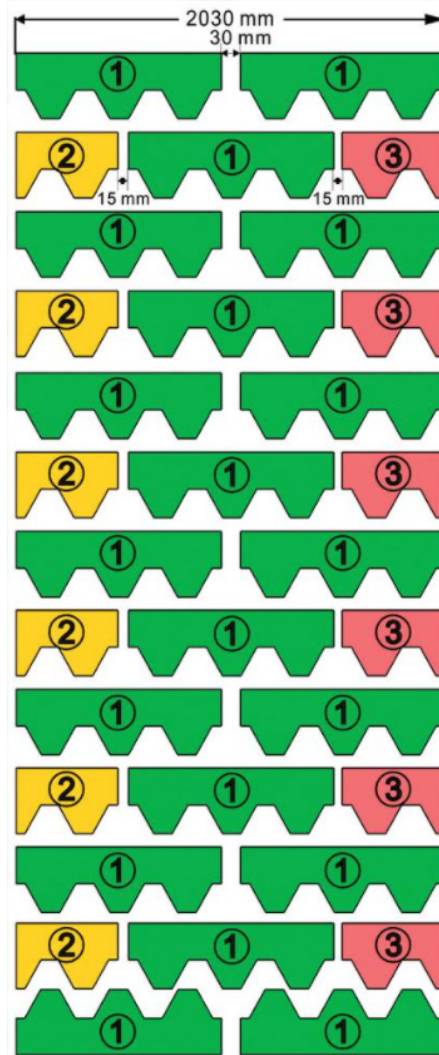
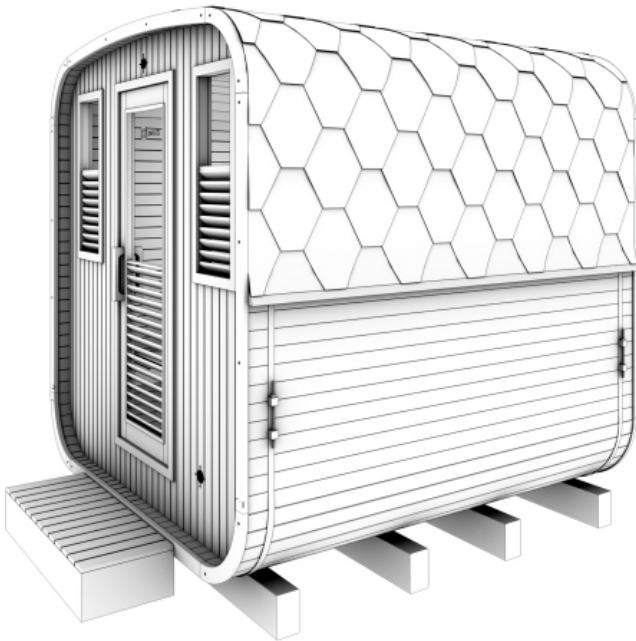

① 1000*320=49

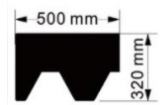

② 500*320=14

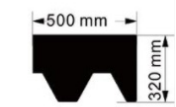

③ 500*320=14

Fase 18:

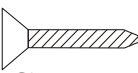
4x  Ø 4 x 25
27

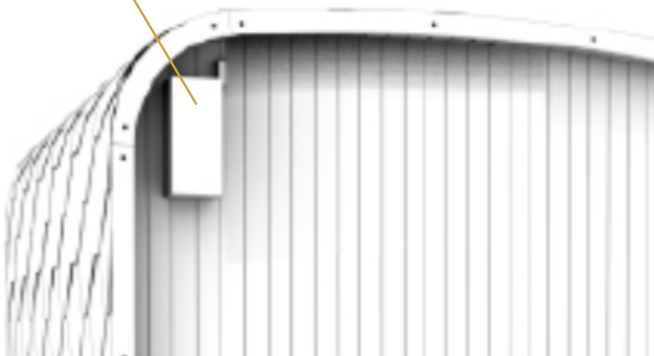

1: connect

2: fix



Garanzia

Manutenzione

ATTENZIONE:

Prima di ogni intervento, scollegare il cavo d'alimentazione della cabina.

Problemi riscontrati	Possibili motivi	Soluzioni
La stufa elettrica non scalda.	Il cavo dell'alimentazione è scollegato.	Verificare il collegamento del cavo dell'alimentazione.
	L'alimentazione generale è staccata.	Verificare il corretto funzionamento del quadro elettrico e della presa a muro.
	La stufa è in sicurezza-surriscaldamento.	Consultare il manuale della stufa elettrica.
L'illuminazione della sauna non funziona più.	Il cavo di alimentazione della lampada non è collegato correttamente.	Collegare il cavo di alimentazione.
	La lampada è difettoso.	Contattare il rivenditore.

Manutenzione

1. Scollegare la sauna.
2. Utilizzare un aspiratore per rimuovere tutti i residui di polvere rimasti negli interstizi del legno.
3. Pulire la cabina con una salvietta umida di cotone, se necessario utilizzare una piccola quantità di sapone. Risciacquare utilizzando una salvietta umida.
4. Pulire il vetro con un detergente per vetri e un panno morbido.
5. Mantenere l'esterno della sauna ogni 2 anni con un prodotto adatto.
6. In caso di pioggia battente, all'interno della sauna possono comparire degli oreoli, non si tratta di una perdita dovuta all'azione capillare.

ATTENZIONE:

Il legno deve essere trattato con un prodotto protettivo solo all'esterno della sauna.

Nessun trattamento deve essere applicato all'interno della sauna.

Non utilizzare benzene, alcool, prodotti chimici o detergenti aggressivi sulla sauna, in quanto i prodotti chimici possono danneggiare il legno e lo strato di protezione che si trova sul legno. Non vaporizzare acqua sulla sauna.

Garanzia

Tutti gli elementi che compongono le saune sono garantiti 2 anni e 4 anni per le parti in legno.

La data di entrata in vigore della garanzia è la data di spedizione (corrispondente alla data di emissione della fattura).

La garanzia non si applica nei casi seguenti:

- Malfunzionamento o danno derivante da un'installazione, da un utilizzo o da una riparazione non conforme alle istruzioni di sicurezza.
- Malfunzionamento o danno derivante da condizioni non adatte all'uso inizialmente previsto dell'apparecchio.
- Danno derivante da una negligenza o da un caso di forza maggiore (temporale e intemperie).
- Malfunzionamento o danno derivante dall'uso di accessori non autorizzati.
- Malfunzionamento o danno derivante dalla mancata installazione di un tetto impermeabile.
- Malfunzionamento o danno derivante dalla mancata manutenzione della parte esterna della sauna.

La garanzia non si fa carico delle spese connesse ad un trasporto della cabina o di una parte dei suoi componenti presso i nostri stabilimenti in Francia. Nell'ambito della garanzia, in caso di guasto, i pezzi ritenuti difettosi dai nostri tecnici saranno sostituiti. Le informazioni e le spiegazioni necessarie alla loro installazione saranno fornite da uno dei nostri tecnici. Le spese legate all'uso di una manodopera di parti terze non saranno prese in carico da Holl's.



IMPORTANTE

Non restituire il prodotto al negozio

Rivolgersi al centro di assistenza post-vendita su
www.holls.fr o **POOLSTAR**
960 Avenue Olivier Perroy, 13790 ROUSSET - FRANCE

Controller LED

	Scatola di controllo a LED	Telecomando
Temperatura di esercizio	-30 ° C / 60 ° C	-30 ° C / 60 ° C
Tensione	CD5V / 12 / 24V DC	2 pile NO7 - 3V
produzione	Uscita aperta di drenaggio N-MOS a 3 canali	-
Consumo di energia	0.5W	0.09mW
Produzione	6A 3 canaux: 18A 6A	
Dimensioni della scatola	83 x 79 x 33 cm	

funzioni:

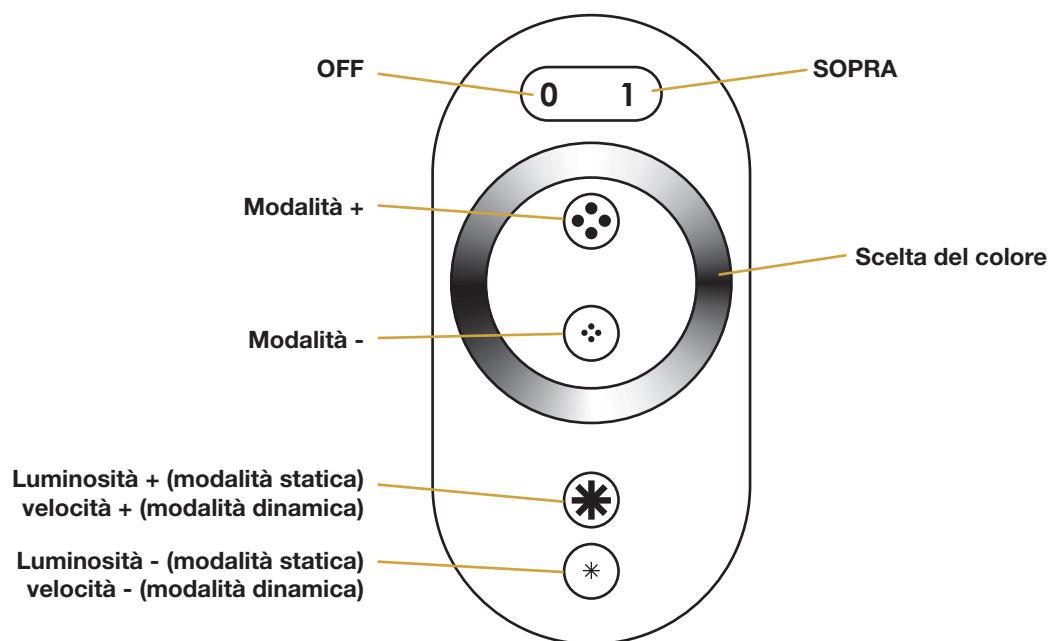

Mode	illuminazione	Commenti		
1	rosso statico (R)	Luminosità, regolabile	10	3 transizione di colore (G / B / R)
2	verde statico (G)		11	5 transizione di colore (G / B / P / R / Y)
3	blu statico (B)		12	7 transizione di colore (G / B / Y / P / LB / W / R)
4	giallo statico (Y)		13	5 onde di colore (R / Y / G / B / W)
5	viola statico (P)		14	Flash a 3 colori (R / G / B)
6	blu chiaro statico (LB)		15	Flash a 7 colori (W / R / G / B / Y / P / LB)
7	bianco statico (W)		16	Flash dinamico a 3 colori (R / G / B)
8	Salta tra 3 colori (G / B / R)	Adjustable speed and brightness	17	Flash dinamico a 7 colori (R / G / B / Y / P / LB / W)
9	Salta tra 7 colori (R / G / B / Y / P / LB / W)		18	Automatico
			Velocità e luminosità regolabili	

A large white rectangular area containing 20 horizontal gold-colored lines, spaced evenly for writing.

Warnungen

Lesen Sie vor der Erstbenutzung Ihrer Sauna aufmerksam diese Gebrauchsanweisung.

Wir raten Ihnen die Gebrauchsanweisung für spätere Nutzungsempfehlungen sicher aufzubewahren.

- Holz ist ein lebendiges Element, um sein ursprüngliches Aussehen zu erhalten, ist es wichtig, die Außenseite des Holzes gegen Feuchtigkeit zu behandeln.
Verwenden Sie einen Sättiger nur an der Außenseite der Sauna.
- Die Sauna auf einem absolut flachen Boden installieren.
- Die Sauna muss im trockenen bleiben. Nicht neben einer Wasserstelle benutzen (Badewanne, feuchter Boden, Schwimmbecken).
- Keine flüssigen Reinigungsmittel verwenden. Ziehen Sie vor der Reinigung den Netzstecker aus der Steckdose und benutzen Sie ein feuchtes Tuch (Siehe Kap. Instandhaltung).
- Schützen Sie das Netzkabel der Sauna vor Knickungen und davor, dass niemand darauf treten kann.
- Bevor Sie bestimmte Teile austauschen, überzeugen Sie sich davon, dass diese vom Hersteller konzipiert worden sind oder den Eigenschaften der ursprünglichen Teile gleich kommen. Ein falscher Austausch der Teile kann zu einem Brand, einem Kurzschluss oder zur Beschädigung der Sauna führen. Wir empfehlen dringend einen Fachmann herbei zu ziehen.
- Zur Vermeidung von Verbrennungen oder Stromschlägen benutzen Sie kein Werkzeug aus Metall.
- Nehmen Sie keine Tiere mit in die Sauna.
- Lassen Sie die Sauna nicht unbeaufsichtigt eingeschaltet.
- Lassen Sie die Sauna nicht länger als 3 Stunden an einem Stück in Betrieb, um eine vorzeitige Beschädigung der Geräte zu vermeiden. Nach einer 3-stündigen kontinuierlichen Nutzung schalten Sie die Sauna mindestens eine Stunde lang aus.
- Wir empfehlen Ihnen kein Schließsystem an die Tür der Sauna anzubringen.
- Bevor Sie Ihre Sauna an das Stromversorgungsnetz anschließen, überprüfen Sie die Konformität Ihrer Hausinstallation.

**Notieren und bewahren Sie die Seriennummern der Sauna sowie die Kaufrechnung auf.
Sie können während Ihrer Kundendienstanfrage von Ihnen angefordert werden.**

Sicherheit

ACHTUNG:

Lesen Sie vor der Installation und Nutzung Ihrer Sauna-Kabine aufmerksam die Sicherheitsanweisungen. Diese sind wesentlicher Bestandteil zu Ihrer Sicherheit und müssen unbedingt eingehalten werden.

Vorsicht vor Hyperthermie, Bestrahlung und Hitzschlag, die durch die Nicht-Einhaltung der Sicherheitsanweisungen ausgelöst oder verschärft werden können. Die Anzeichen hierfür sind Fieber, erhöhter Puls, Schwindel, Ohnmacht, Abgeschlagenheit, Taubheitsgefühl des Körpers oder eines Teils des Körpers. Die Auswirkungen: Keine Wahrnehmung der Wärme mehr, Ignoranz der unmittelbaren Gefahr, Bewusstlosigkeit.

Die Sauna darf nicht benutzt werden von:

- Kinder unter 6 Jahren.
- Personen mit starken Reaktionen auf Sonnenbestrahlung.
- Ältere Personen oder Personen mit Behinderung.
- Personen mit medizinischer Vorgeschichte, sowie z.B. durch Herzkrankheiten, Bluthochdruck / Hypotonie, Blutkreislaufproblemen oder Diabetes ohne vorherige ärztliche Absprache.
- Frauen bei denen eine Schwangerschaft besteht. Eine übermäßige Temperatur kann für den Fötus gefährlich sein.
- Personen, die unter Dehydratation, offenen Wunden, Erkrankungen der Augen, Verbrennungen, Sonnenbrand leiden.

Kinder zwischen 6 und 16 Jahren können die Sauna unter ständiger Aufsicht eines verantwortlichen Erwachsenen und unter der Bedingung, dass die Temperatur nicht 60°C (140°F) übersteigt, benutzen.

Bei gesundheitlichen Problemen, der Einnahme von Medikamenten, Muskel- oder Bandverletzungen, benutzen Sie die Sauna nicht ohne vorherige ärztliche Beratung und Einverständnis.

Im Fall von chirurgischen Implantaten, benutzen Sie die Sauna nicht ohne vorherige Beratung und Einverständnis durch den Chirurg.

Benutzen Sie die Sauna nicht nach intensiver Anstrengung. Warten Sie 30 Minuten bis sich Ihr Körper abgekühlt hat.

Keine Saunagänge von über 40 Minuten.

Konsumieren Sie keinen Alkohol oder Drogen vor oder während des Saunagangs.

Schlafen Sie nicht in der Sauna, wenn diese in Betrieb ist.

Um das Risiko der Überhitzung zu vermeiden, verbinden Sie den Stecker Ihrer Sauna mit einer entsprechend leistungsstarken Steckdose, ohne andere elektrische Geräte an dieselbe Wandsteckdose anzuschließen.

Um jeglichen Risiko des Stromschlags oder der Sauna-Beschädigung zu entgehen, benutzen Sie die Sauna nicht:

- bei Gewitter.
- Sollte das Netzkabel beschädigt sein, muss es durch einen Fachmann ausgetauscht werden.
- Sollte das Netzkabel überhitzen, muss es durch einen Fachmann ausgetauscht werden.
- Wenn Sie eine Glühbirne austauschen müssen, warten Sie bis die Sauna abgeschaltet und abgekühlt ist.

Bevor Sie den Netzstecker ein- oder ausstecken, trocknen Sie sich die Hände. Handeln Sie niemals mit feuchten Händen oder Füßen.

Schalten Sie die Stromversorgung oder das Heizsystem nicht willkürlich ein und aus, da dies dem elektrischen System Schaden zufügen könnte.

Versuchen Sie nicht die Sauna ohne das Einverständnis des Händlers oder des Herstellers selbst zu reparieren. Ungenehmigte Reparatur-Versuche führen zum Erlöschen der Händlergarantie.

Verwenden Sie nicht irgendeine Art von Reinigungsmittel im Inneren der Sauna.

Lagern oder Stapeln Sie keine Gegenstände im Inneren der Sauna.

Bewahren Sie keine entzündbaren Materialien oder chemischen Mittel in der Nähe der Sauna auf.



Beschreibung der Sauna

Technische Merkmale

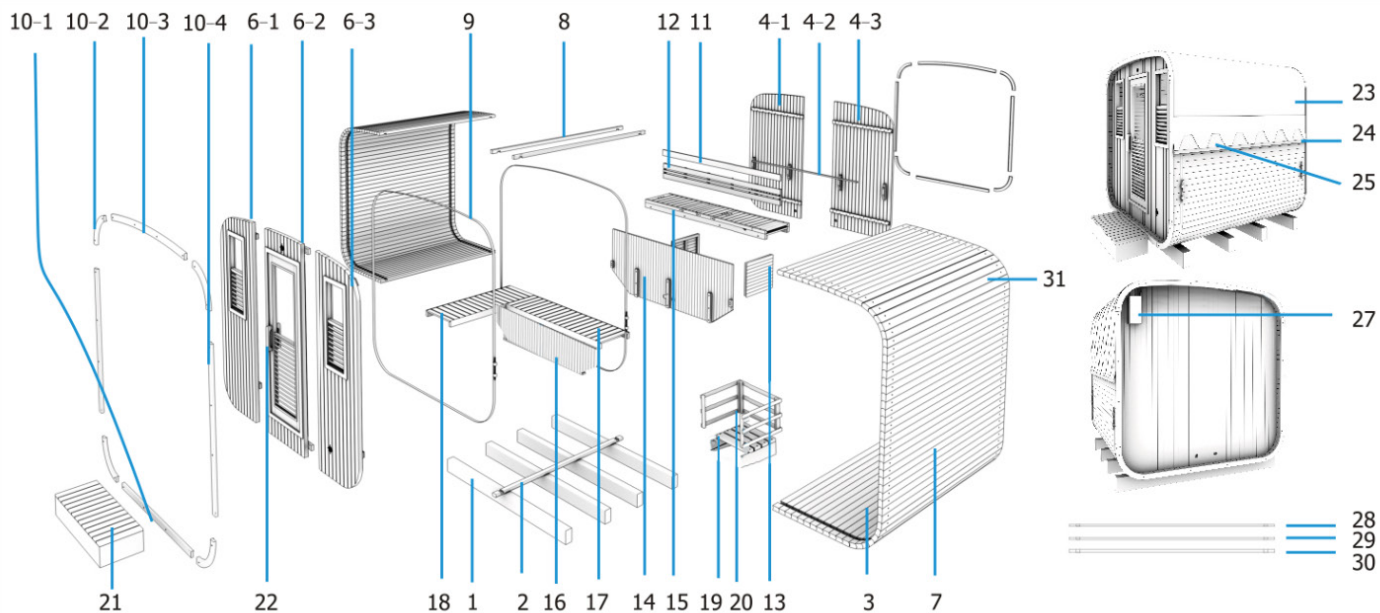
Modell	HL-B200E
Holz	Kanadische Fichte
Voltzahl	230 V - 50 Hz (ohne Herd)

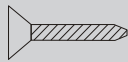
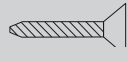

N°	MENGE	Name
1	4	Fasswiegen 1980x70x150
2	1	Spezielle Bodenlatte (beidseitig konvex)
3	16	speciali doghe laterali senza fori
3-2	2	speciali doghe laterali con fori
4-1	1	Rückwandteil (links)
4-2	1	Rückwand-Verbindungsstange
4-3	1	Rückwandteil (rechts)
6-1	1	Vorderwandabschnitt (linkes Fenster)
6-2	1	Vorderwandteil (Glastür)
6-3	1	Vorderwandteil (rechtes Fenster)
7	52	1998x85x38mm Standard Saunalatte
8	2	76 * 38mm Spezielle obere Lamelle (einseitig konvex)
9	2	Saunabänder aus Edelstahl
10-1	2	Dekorative Traufe (unten)
10-2	4	Dekorative Traufe (Ecke)
10-3	2	Dekorative Traufe (oben)
10-4	4	Dekorative Traufe (Seite)
11	1	LED Lichtstrahl
12	1	Rückenlehne
13	2	Obere Bankplatte (Seite)
14	1	Obere Sitzplatte (vorne)
15	1	Obere Bankplatte (faltbar)
16	1	Niedrige Bankhalterung

	Größe	MENGE
	Ø 5 x 50	32
	Ø 4 x 40	188
	Ø 4 x 25	8
	Ø 3 x 18	6
	Ø 3 x 16	250
	Ø 6 x 75	2
	Ø 4 x 12	4
	Allen key 1	1
	Allen key 2	1

Installation

17	1	Niedrige Bank
18	1	Seitenbank
19	1	Halterung für Saunaofen (mit Wasserschale)
20	1	Saunaofengrill (drei Teile pro Set)
21	1	Eingangsstufe
22	1	Türschnalle
23	1	Regenmantel (grau)
24	2	Wassernase
25	100	Asphaltschindel (grau)
26	1	Kabelabdeckung
27	1	Kontrollkasten
28	1	Oberfülllatte (10mm)
29	1	Oberfülllatte (15mm)
30	1	Oberfülllatte (20mm)
31	16	Spezielle Ecklatte (70x38mm) mit Loch
31-2	16	Spezielle Ecklatte (70x38mm) ohne Loch

Lesen Sie aufmerksam die Montageanleitung bevor Sie mit dem Zusammenbau beginnen.

Wahl des Aufstellorts

Holl's Saunen sind ausschließlich für den äußere-Aufbau geeignet.

Wählen Sie die Stellfläche:

- Im Trocknen, auf einem flachen und stabilen Boden, der das Gewicht Ihrer Sauna tragen kann.
- Die Raumhöhe muss ausreichen, um den Zugang auf das Dach zur Durchführung der Elektroanschlüsse und der Instandhaltung zu gewährleisten.
- Entfernt von Wasserstellen, offenen Flammen und entzündbaren Substanzen.

Für die Außensauna ist eine Betonplatte erforderlich, die vollkommen flach, waagrecht und trocken ist, da sonst die korrekte Montage gefährdet sein könnte.

Praktische Ratschläge

- Achten Sie darauf, dass die Montage der Sauna zwei bis drei Erwachsene Personen erfordert.
- Ermitteln Sie deutlich jedes Wandteil bevor Sie beginnen.
- Während der Montage richten Sie die Sauna so aus, dass das Netzkabel gut erreichbar bleibt.
- Achten Sie darauf, dass es je nach Modell verschiedene Varianten gibt.

ACHTUNG:

Kontrollieren Sie die Bohrungen und deren Durchmesser, um Holzbeschädigungen zu vermeiden.
Die erforderliche Mindesthöhe für die Installation beträgt 2020 mm.

Werkzeuge benötigt



Kreuzschlitz-
schraubenzieher



Meter



Trittleiter



Bleistift



Tapetenmesser

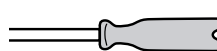

2 Flacher Schlüssel
(19 mm)

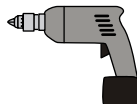

Elektroschrau-
ber

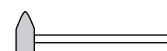

Holzham-
mer



Holzspiralbohrer



Innen-
sechskantschlüssel

Montage

Montageschritte

Schritt 1:

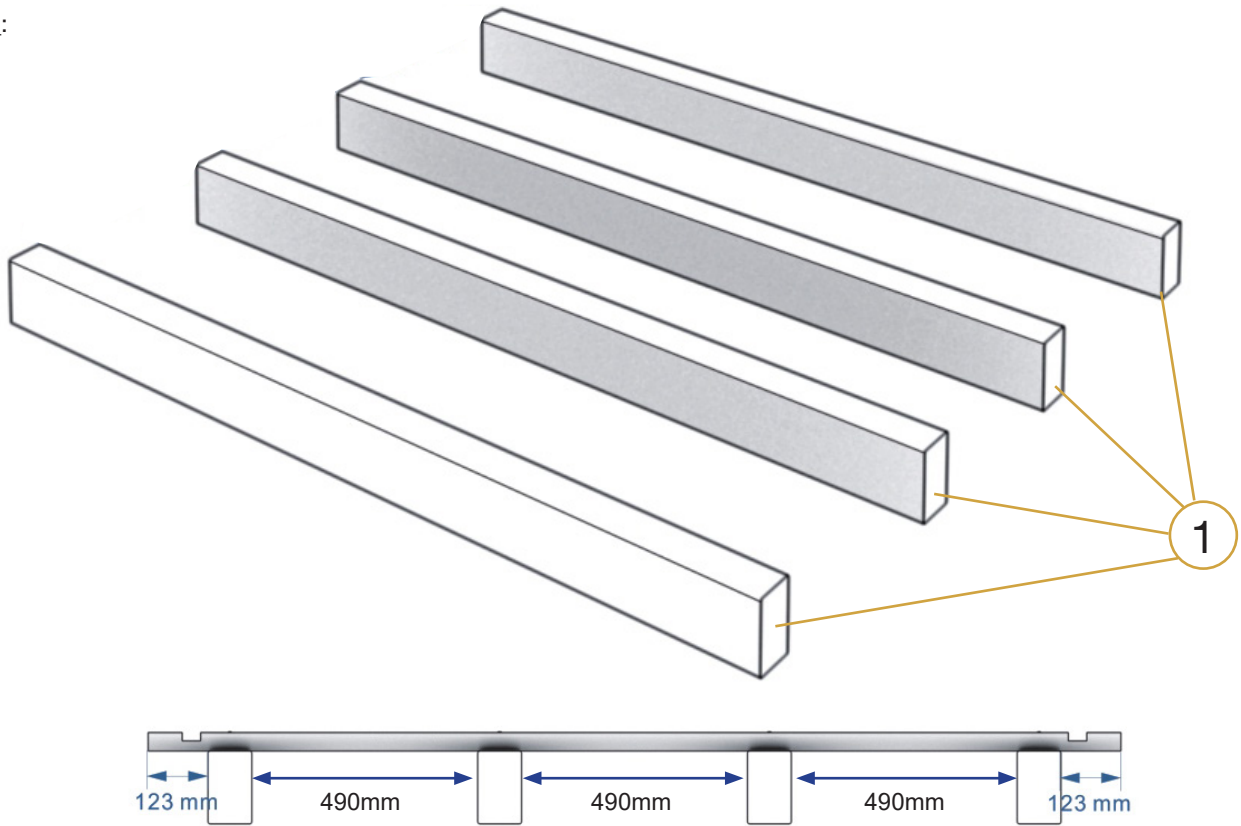

Schritt 2:

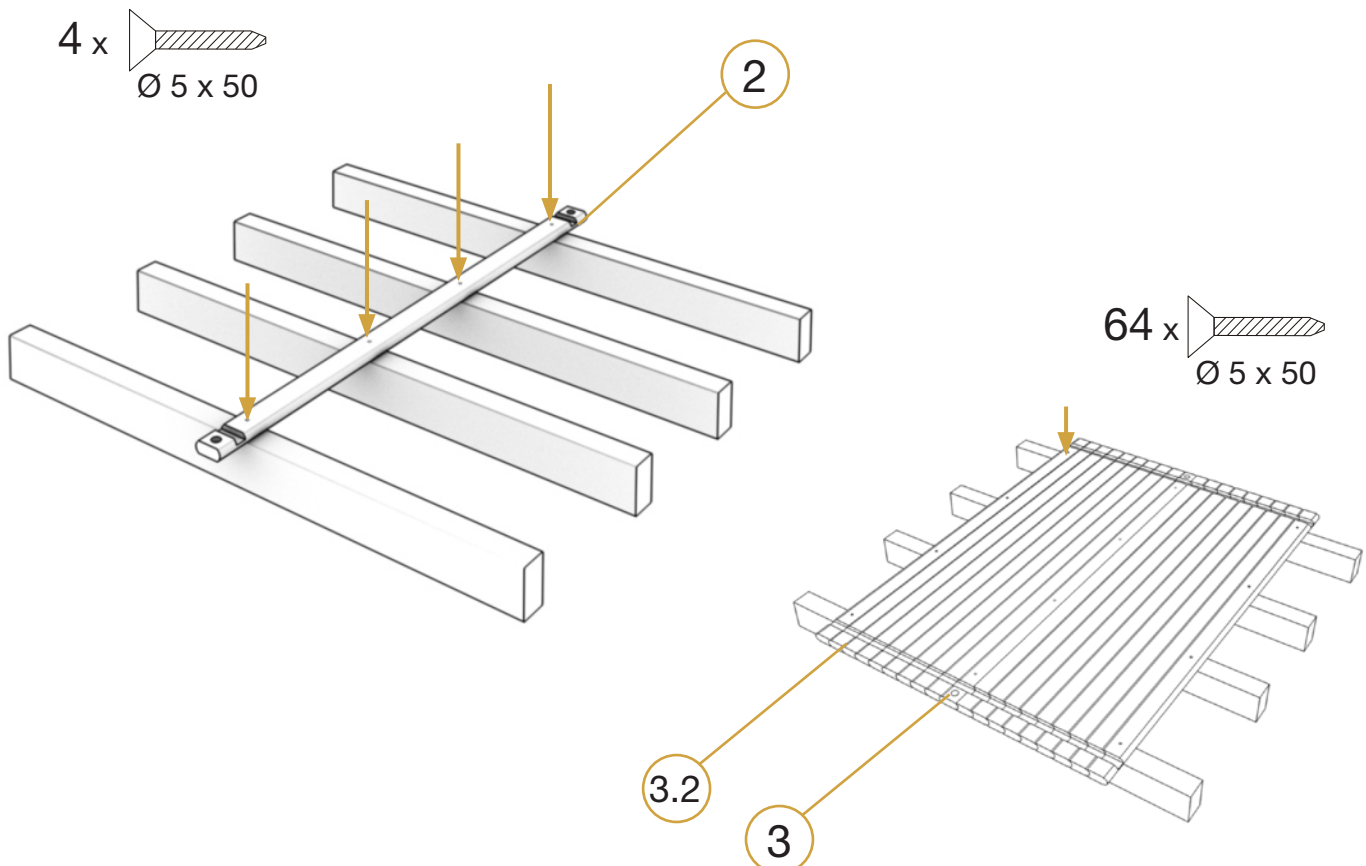

Montage

Step 3:

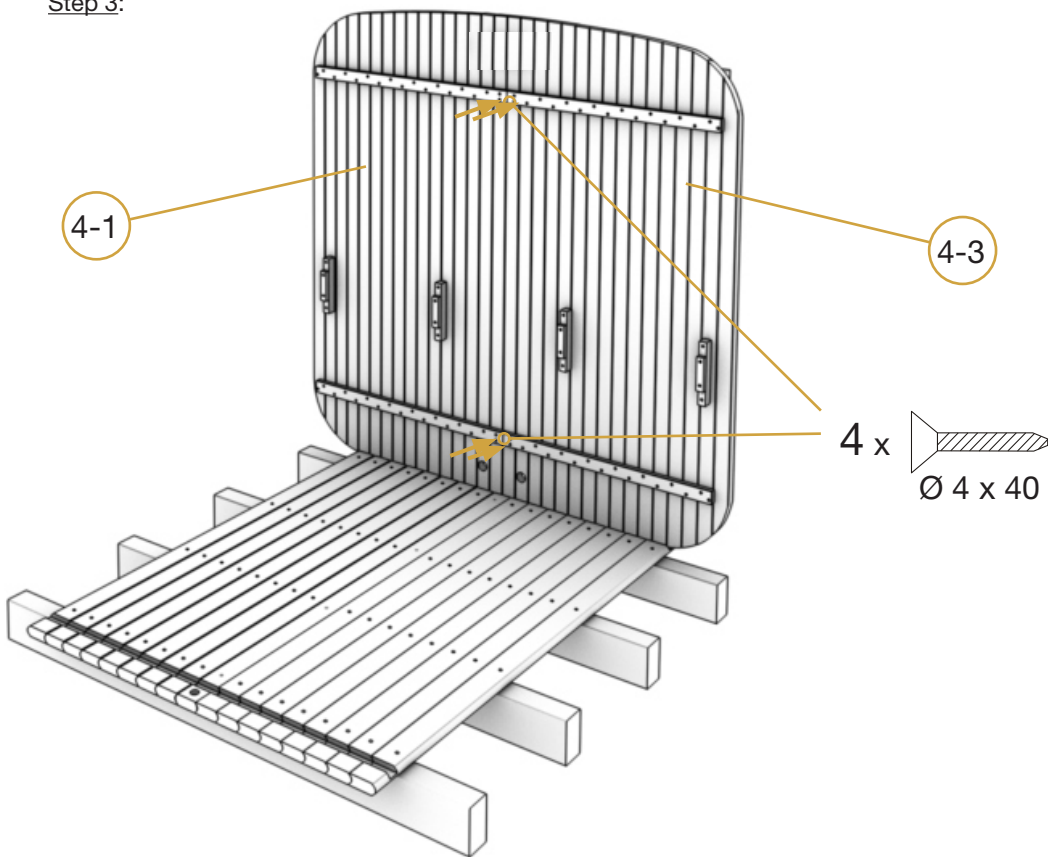

Step 4:

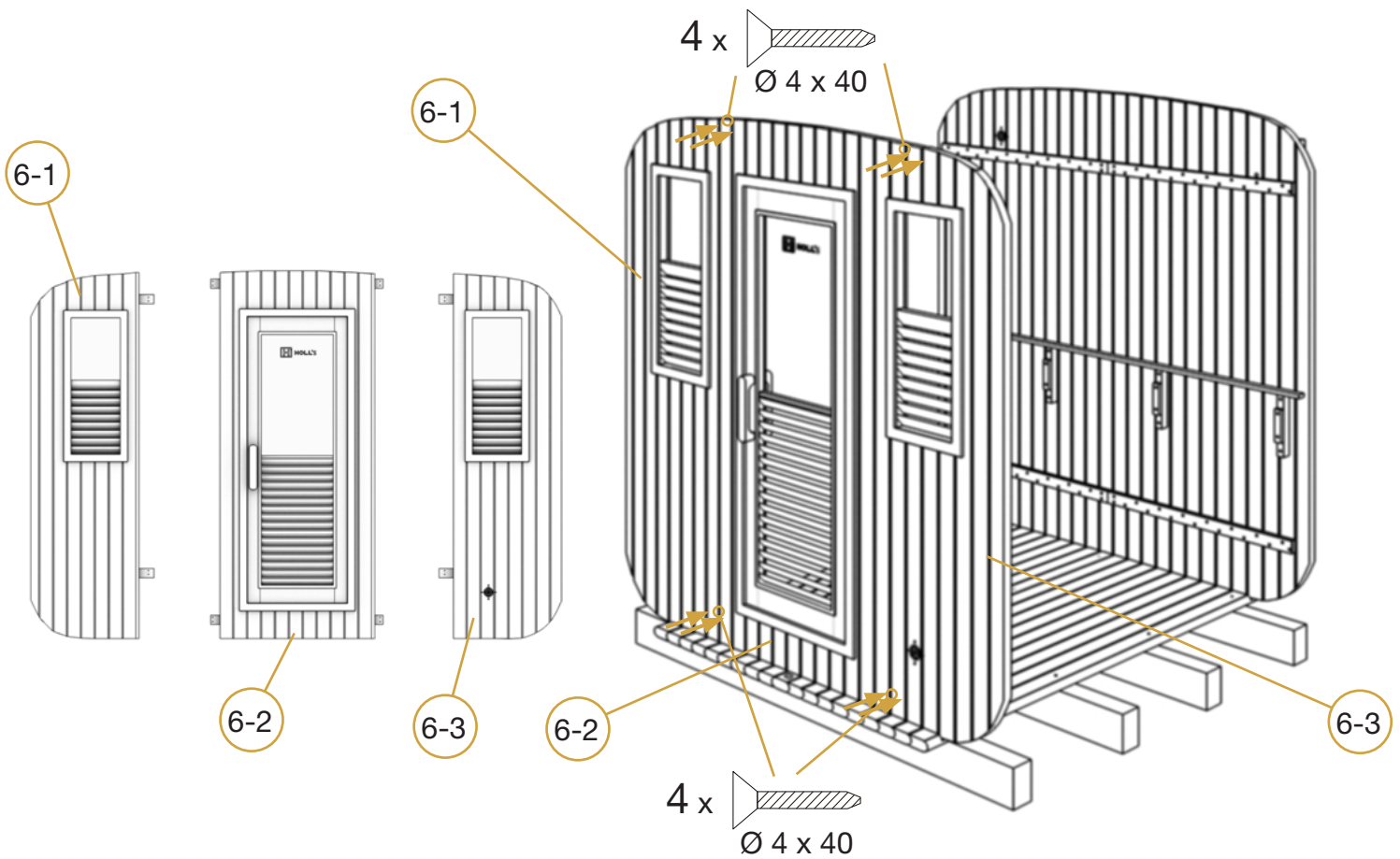

Montage

Step 5:

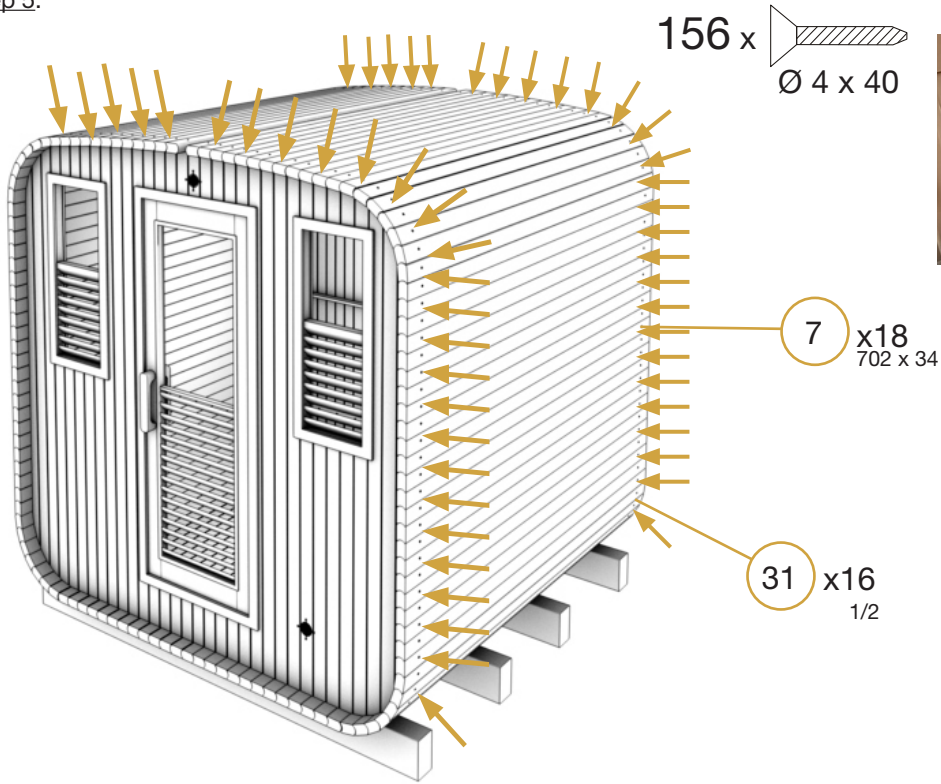

Step 6:

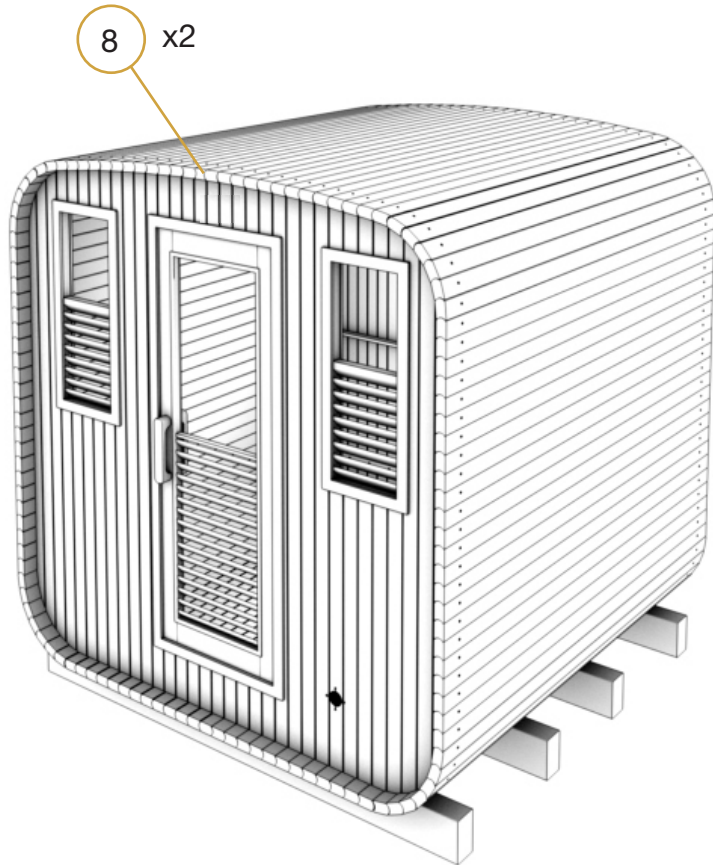

28 / 29 / 30

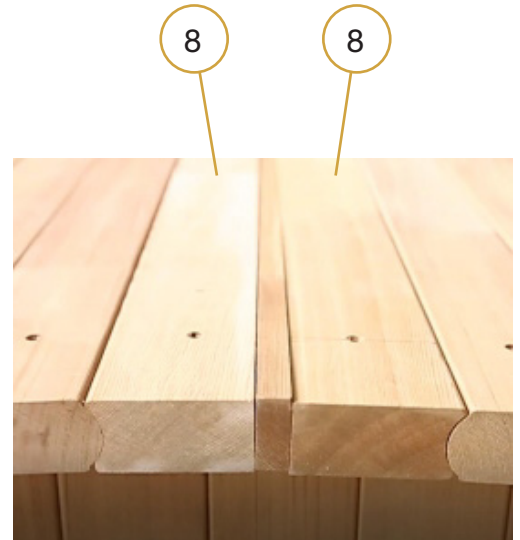

Montage

Step 7:

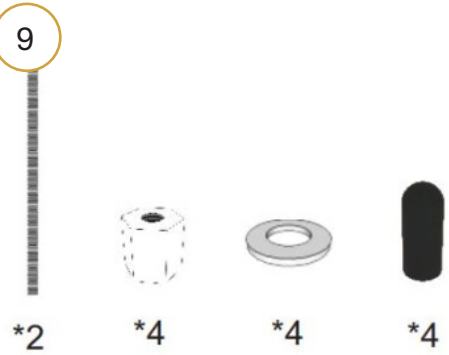
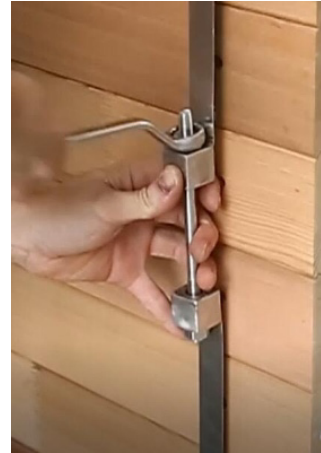
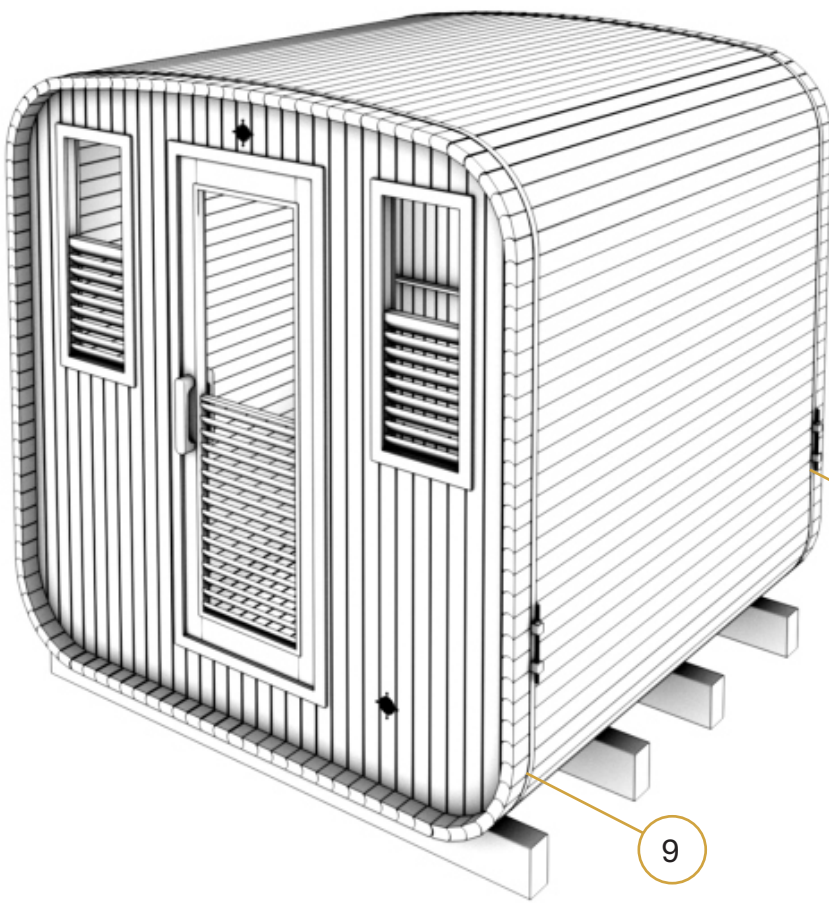

Step 8:

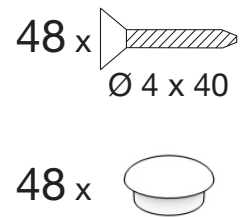
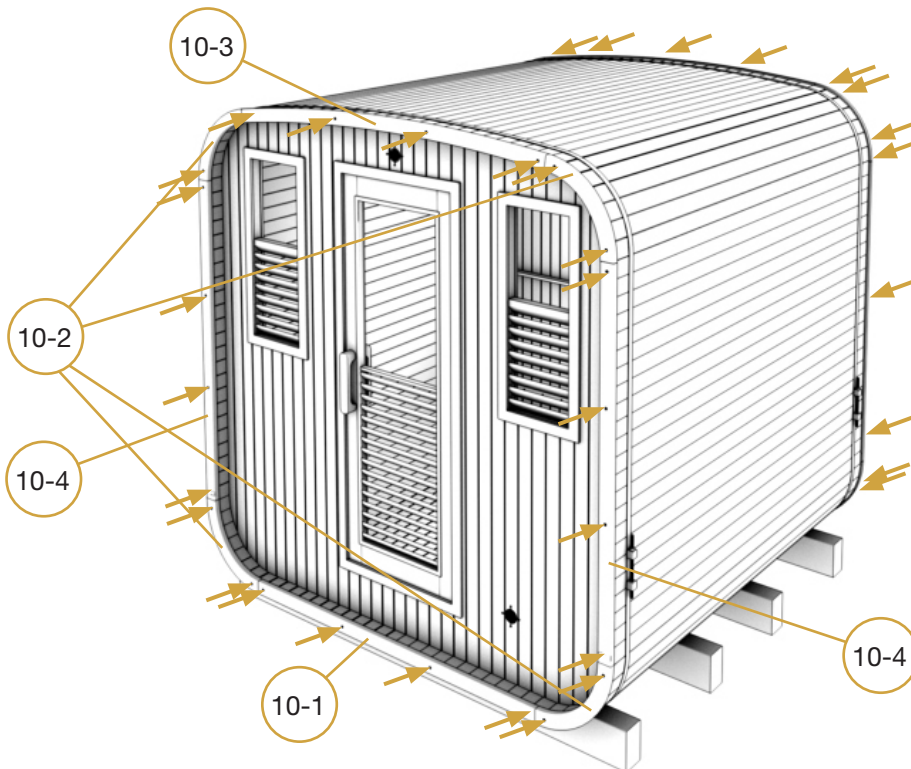

Montage

Step 9:

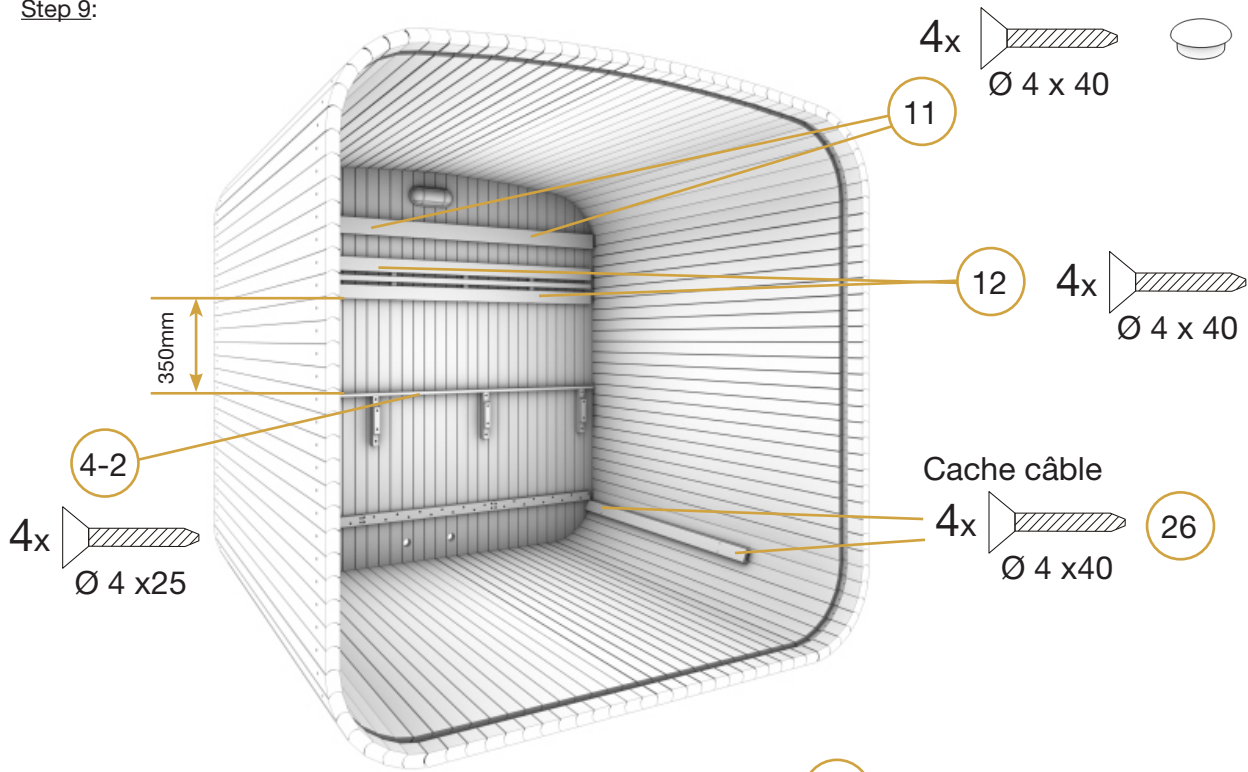

Step 10:

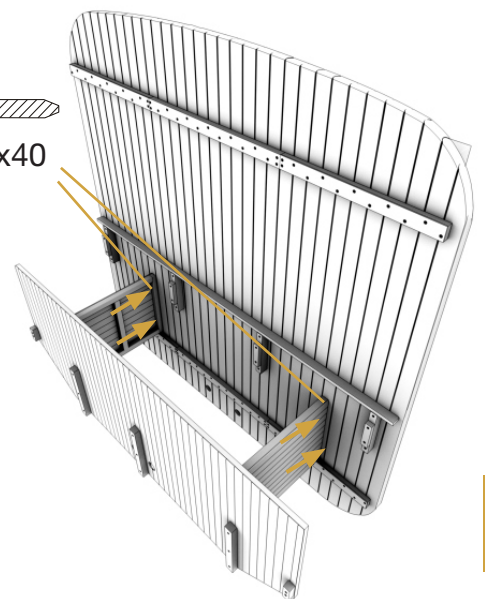
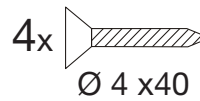
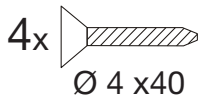
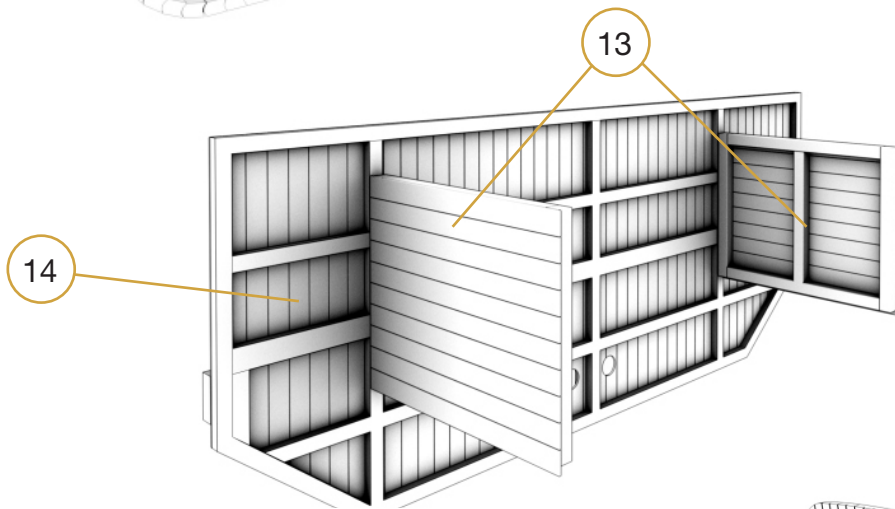

Step 11:

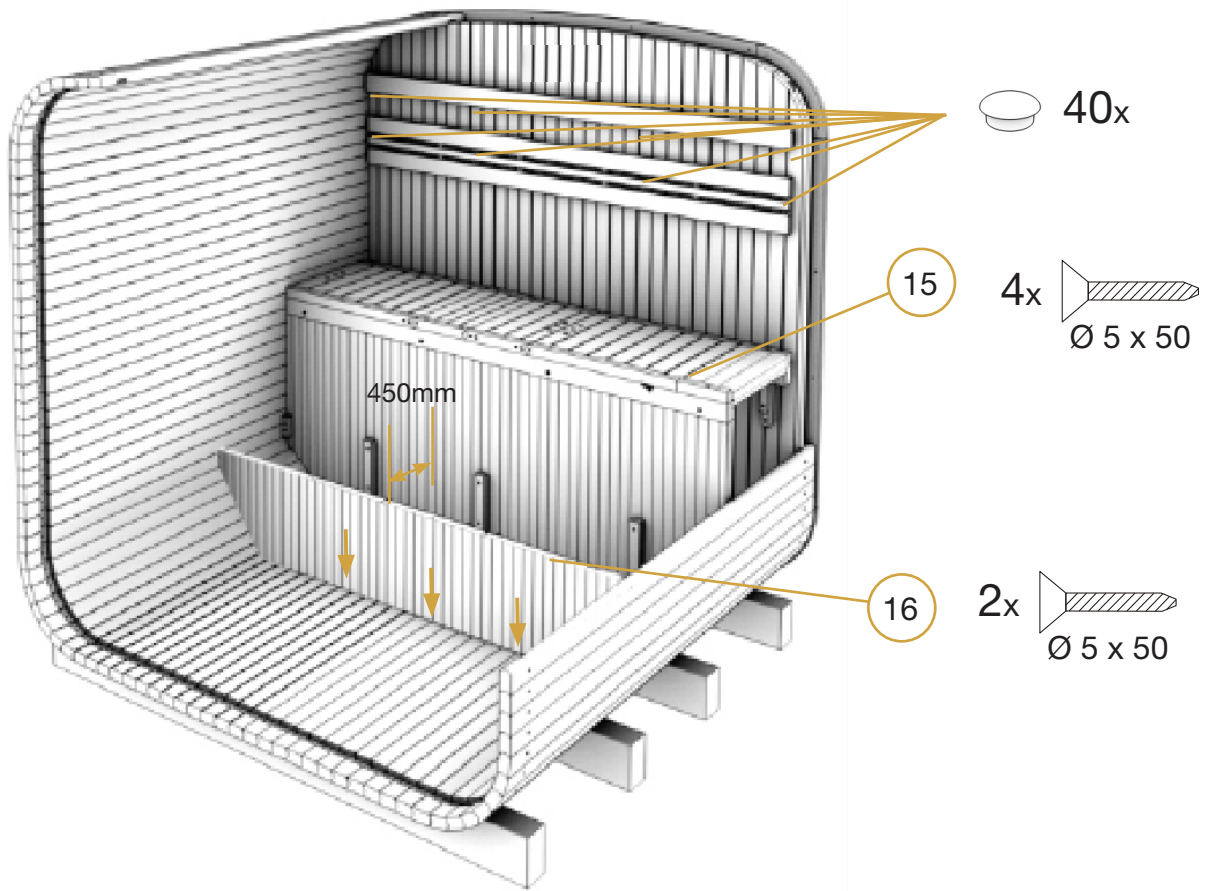

Step 12:

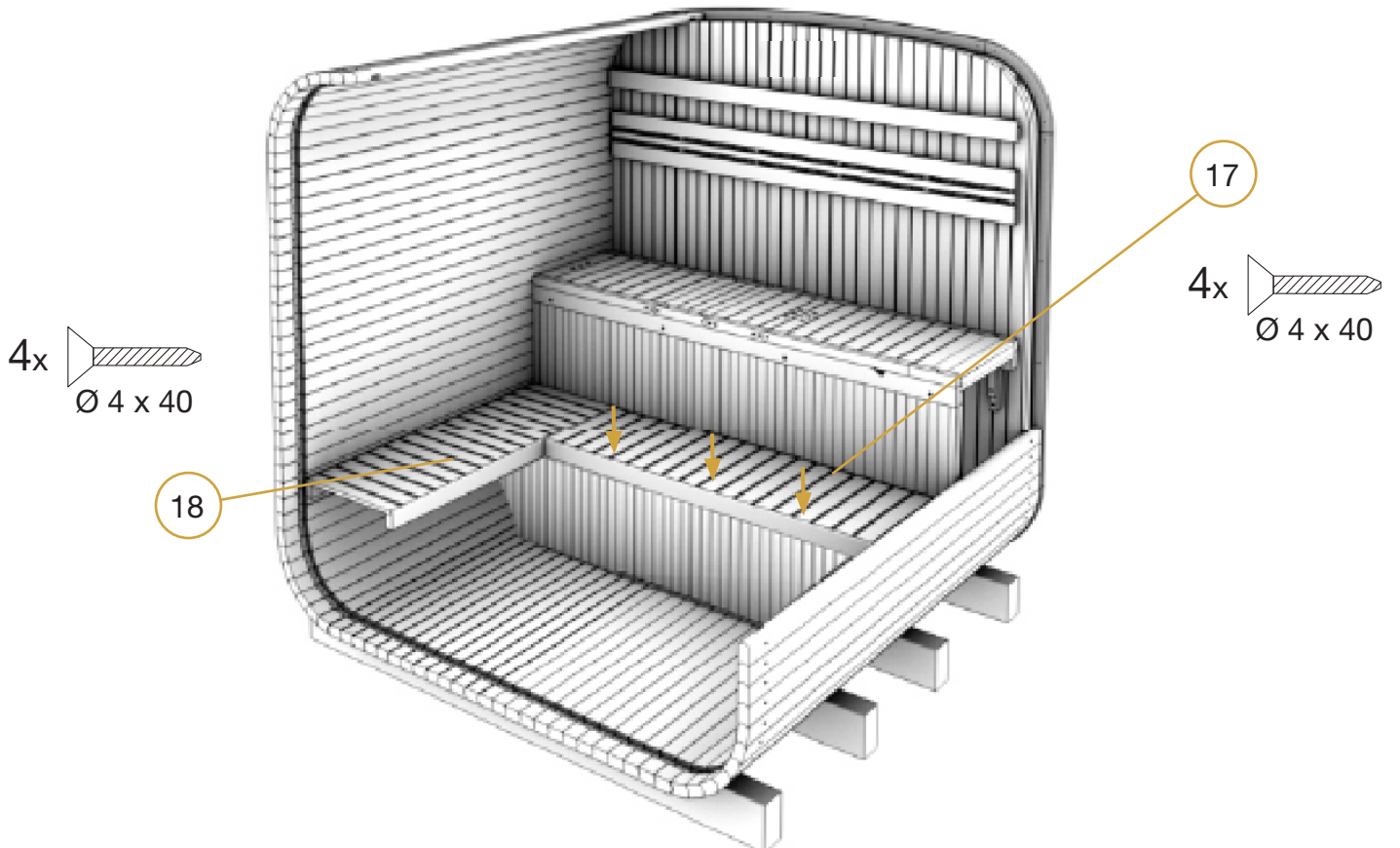

Step 13:

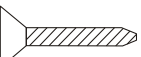

2x 
Ø 5 x 50

19

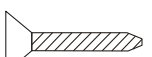
8x 
Ø 4 x 40

20

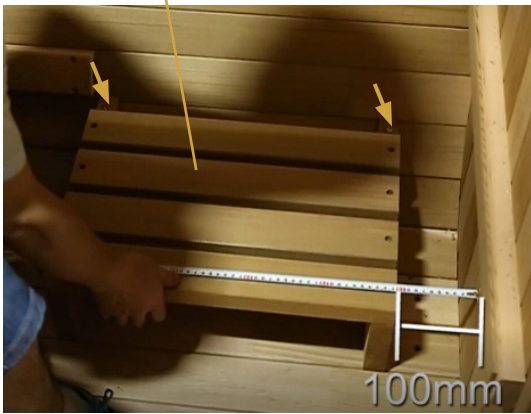

Step 14:

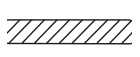

2x 
Ø 6 x 70

21

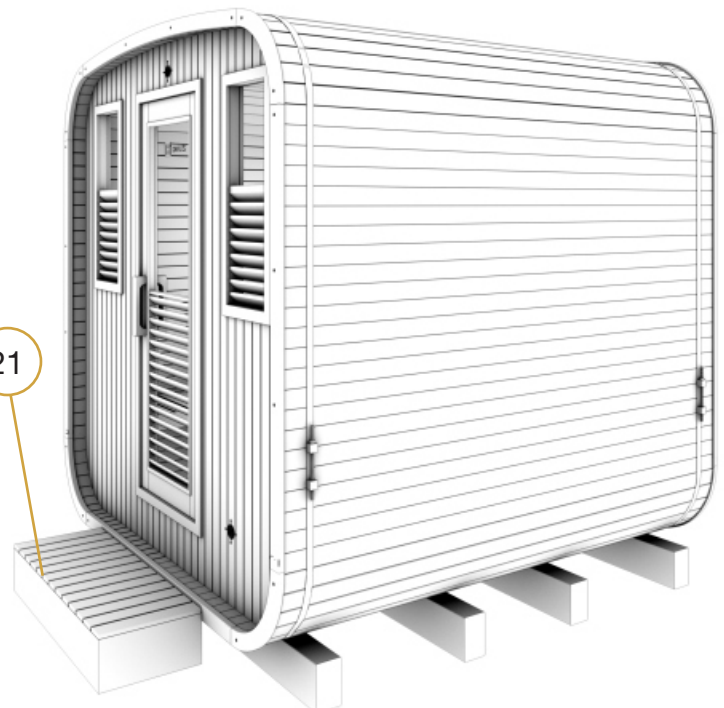

Montage

WICHTIG:

Die Dacheindeckung ist unerlässlich, um die Wasserdichtigkeit der Sauna zu gewährleisten, sie muss der Umgebung angepasst werden.

Step 15:

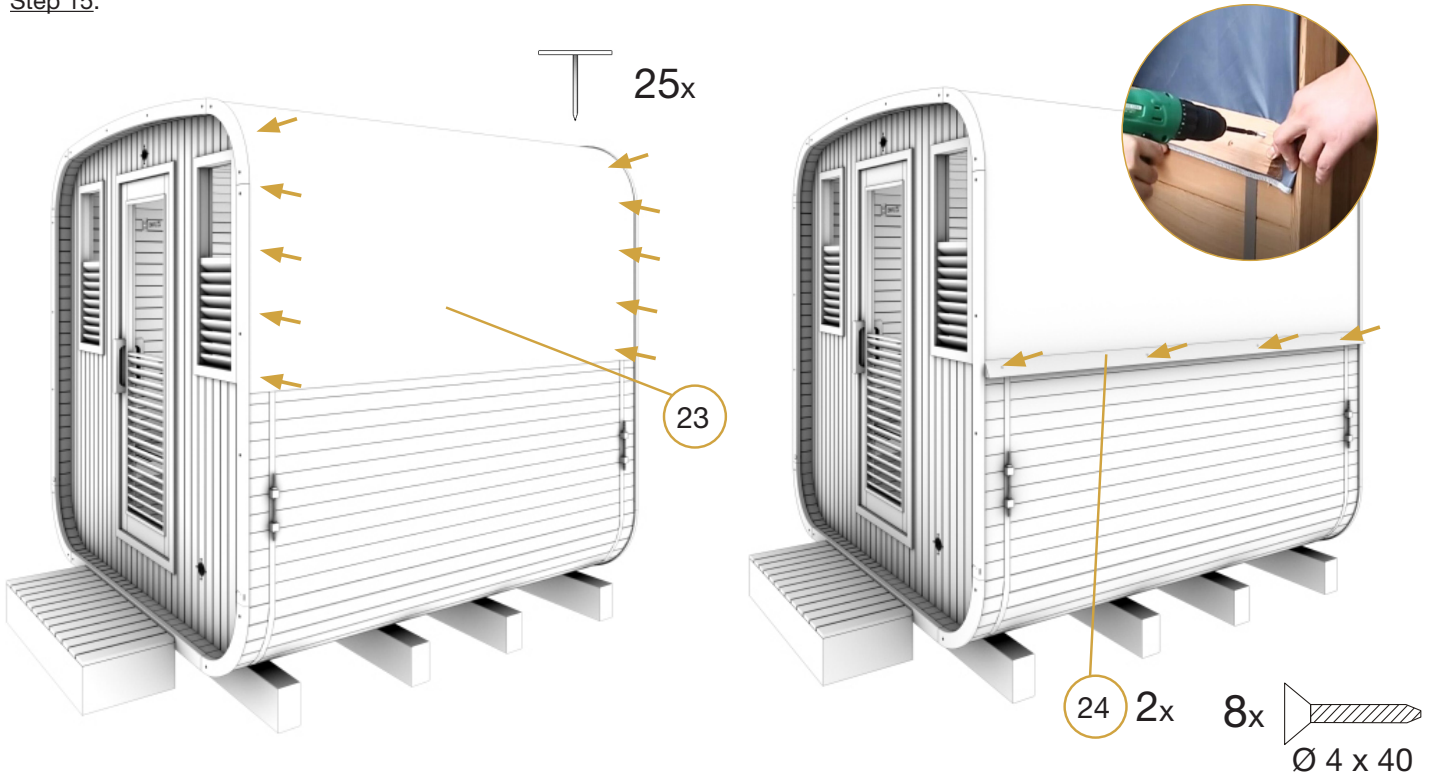

Step 16:

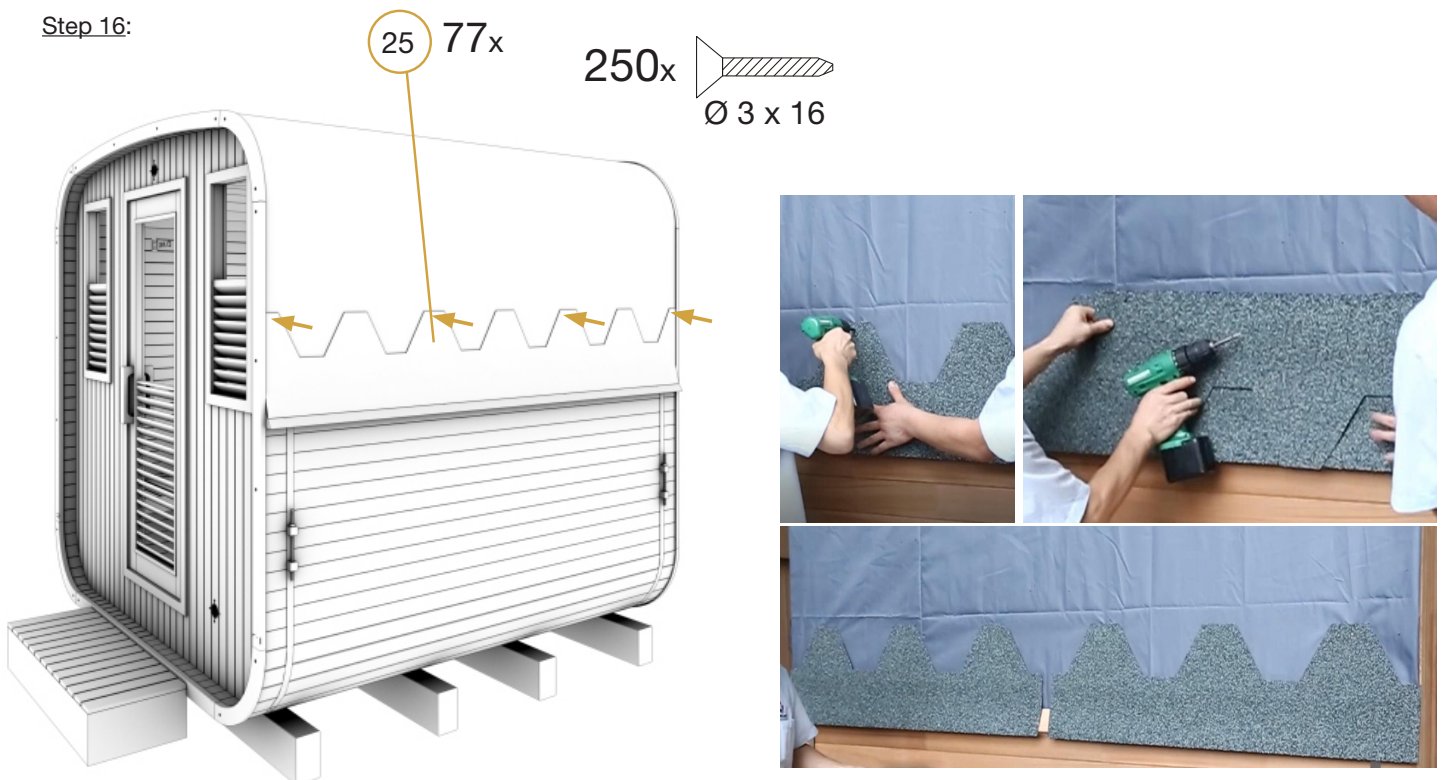

Instandhaltung & Pflege

Step 17:

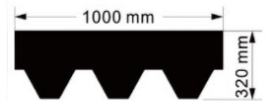
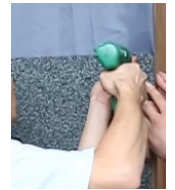
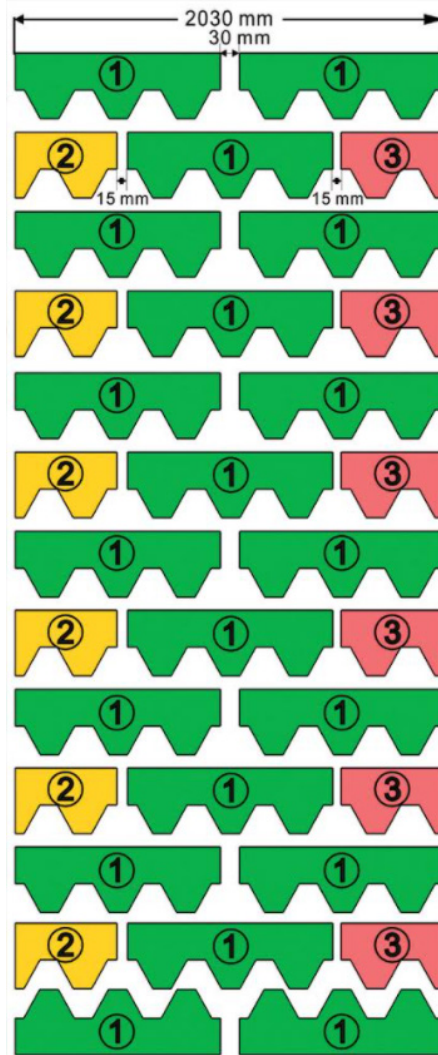
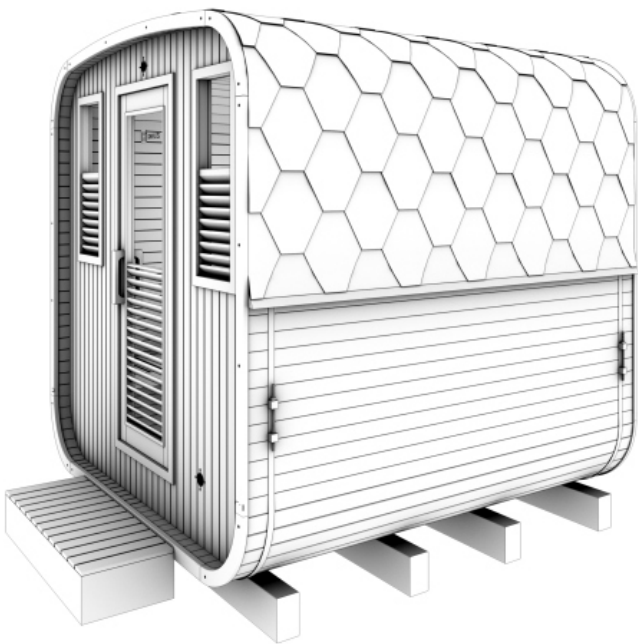

① 1000*320=49

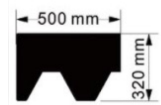

② 500*320=14

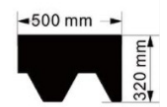

③ 500*320=14

Step 18:

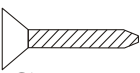
4x  Ø 4 x 25

27

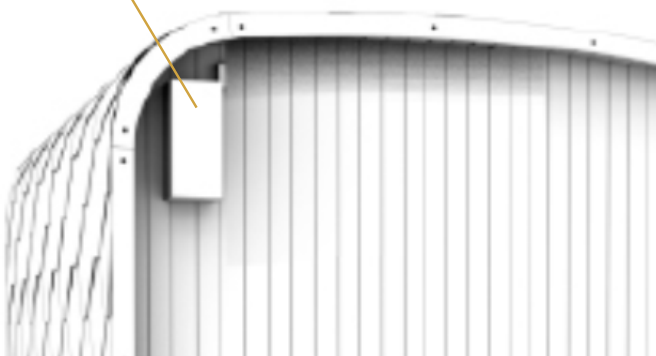

1: connect

2: fix

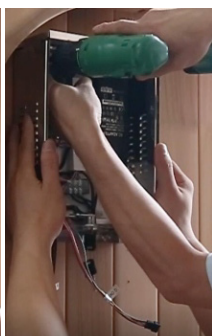

Garantie

Instandhaltung

WICHTIG:

Schließen Sie das Versorgungskabel vor jedem Eingriff ab.

Festgestellte Probleme	Mögliche Ursachen	Lösungen
Der elektrische Ofen heizt nicht.	Das Netzkabel ist ausgesteckt.	Prüfen Sie den Anschluss des Netzkabels.
	Die Hauptzuleitung ist getrennt.	Prüfen Sie die korrekte Funktion der Unterverteilung und der Wandsteckdose.
	Der Ofen befindet sich im Überhitzungsschutz-Betrieb.	Beziehen Sie sich auf die Gebrauchsanweisung des elektrischen Ofens.
Die Beleuchtung der Sauna ist ausgefallen.	Da Lampe Kabel ist nicht ordnungsgemäß angeschlossen.	Schließen Sie das Kabel an.
	Da Lampe sind defekt.	Kontaktieren Sie Ihren Verkäufer.

Pflege

1. Schalten Sie die Sauna ab.
2. Nutzen Sie einen Staubsauger um alle Staubpartikel aus den Schlitzten des Holzes zu entfernen.
3. Reinigen Sie die Sauna-Kabine mit einem feuchten Baumwolltuch, wenn erforderlich verwenden Sie eine kleine Menge Seife. Mit einem feuchten Tuch abspülen.
4. Reinigen Sie das Glas mit einem Glasreiniger und einem weichen Tuch.
5. Pflegen Sie das Äußere der Sauna alle 2 Jahre mit einem geeigneten Produkt.
6. Bei starkem Regen können Oreolen in der Sauna erscheinen, dies ist kein Leck aufgrund von Kapillarwirkung.

ACHTUNG:

Das Holz sollte nur außerhalb der Sauna mit einem Schutzmittel behandelt werden.

In der Sauna darf keine Behandlung durchgeführt werden.

Benutzen Sie kein Benzol, Alkohol, Chemikalien oder starke Reiniger für die Sauna, da die Chemikalien das Holz der Sauna beschädigen können. Sprühen Sie kein Wasser auf die Sauna.

Garantie

Die gesamten Bauteilelemente der Sauna haben eine Garantiezeit von 2 Jahren und 4 Jahre für Holzteile.

Die Garantiezeit wird mit dem Versanddatum wirksam (dies entspricht dem Datum der Rechnungserstellung)

Die Garantie gilt nicht in den folgenden Fällen:

- Störungen oder Beschädigungen, die aus einer Installation, einer Benutzung oder Reparatur herrühren, welche den Sicherheitsbestimmungen nicht entsprechen.
- Störung oder Schaden, welcher auf die nicht bestimmungsgemäße Verwendung des Gerätes zurückzuführen ist.
- Schaden, welcher auf Vernachlässigung, Unfall oder einem Fall von höherer Gewalt zurückzuführen ist (Gewitter und Unwetter).
- Störung oder Schaden infolge einer Benutzung von nicht genehmigten Zubehörteilen.
- Fehlfunktion oder Schäden, die sich aus der Nichtanbringung eines wasserdichten Daches ergeben.
- Fehlfunktionen oder Schäden, die auf die Nicht-Wartung der Saunaaußenseite zurückzuführen sind.

Die Garantie übernimmt nicht die Kosten bezüglich einer Rücksendung der Kabine oder einen Teil ihrer Bestandteile in unsere Werkstätten. Bei Ausfall werden die von unseren Technikern als fehlerhaft erkannte Teile im Rahmen der Garantie ersetzt.

Die zur Installation notwendigen Informationen und Erläuterungen werden von einem unserer Techniker bereitgestellt. Die Kosten zur Beschäftigung einer dritten Arbeitskraft können von Holl's nicht übernommen werden.



WICHTIG

Schicken Sie das Produkt nicht zu Ihrem Händler zurück

Kontaktieren Sie Ihr örtliches Kundendienst-Center auf www.holls.fr oder **POOLSTAR**
960 Avenue Olivier Perroy, 13790 ROUSSET - FRANCE

Controlador LED

	LED-Steuerbox	Fernbedienung
Betriebstemperatur	-30 ° C / 60 ° C.	-30 ° C / 60 ° C.
Stromspannung	CD5V / 12 / 24V DC	2 NO7 - 3V Batterien
Ausgabe	3 Kanäle N-MOS Drain Open Ausgang	- -
Energieverbrauch	0,5 W.	0,09 mW
Ausgabe	6A 3 Kanäle: 18A 6A	
Abmessungen der Box	83 x 79 x 33 cm	

Funktionen:

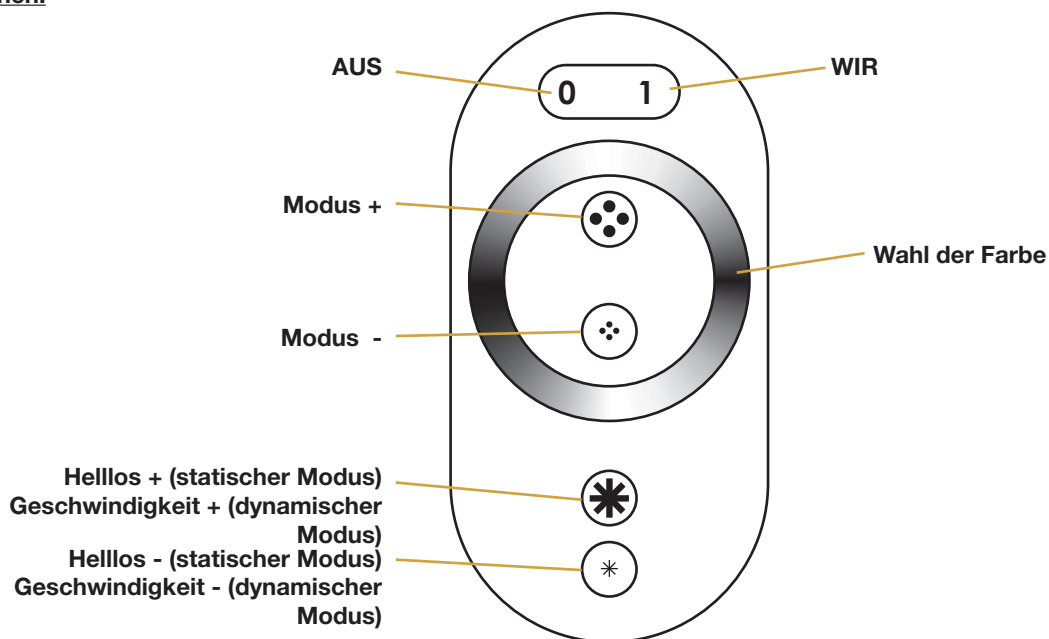

Mode	Beleuchtung	Bemerkungen		
1	statisches Rot (R)	Helligkeit einstellbar	10	3 Farbübergang (G / B / R)
2	statisches Grün (G)		11	5 Farbübergang (G / B / P / R / Y)
3	statisches Blau (B)		12	7 Farbübergang (G / B / Y / P / LB / W / R)
4	statisches Gelb (Y)		13	5 Farbwelle (R / Y / G / B / W)
5	statisches Purpur (P)		14	3 Farbblitz (R / G / B)
6	statisch hellblau (LB)		15	7 Farbblitz (W / R / G / B / Y / P / LB)
7	statisches Weiß (W)		16	Dynamischer 3-Farben-Blitz (R / G / B)
8	Springe zwischen 3 Farben (G / B / R)	Einstellbare Geschwindigkeit und Helligkeit	17	Dynamischer 7-Farben-Blitz (R / G / B / Y / P / LB / W)
9	Springe zwischen 7 Farben (R / G / B / Y / P / LB / W)		18	Automatisch

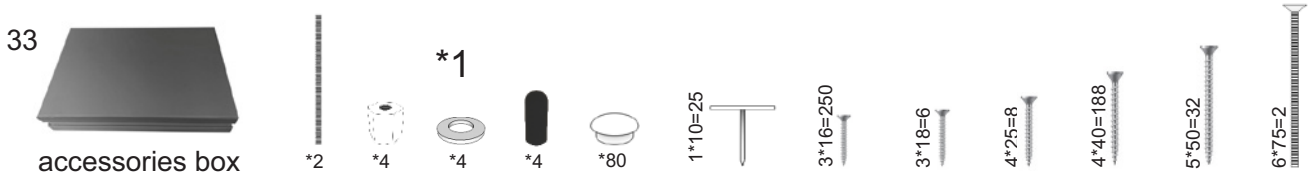
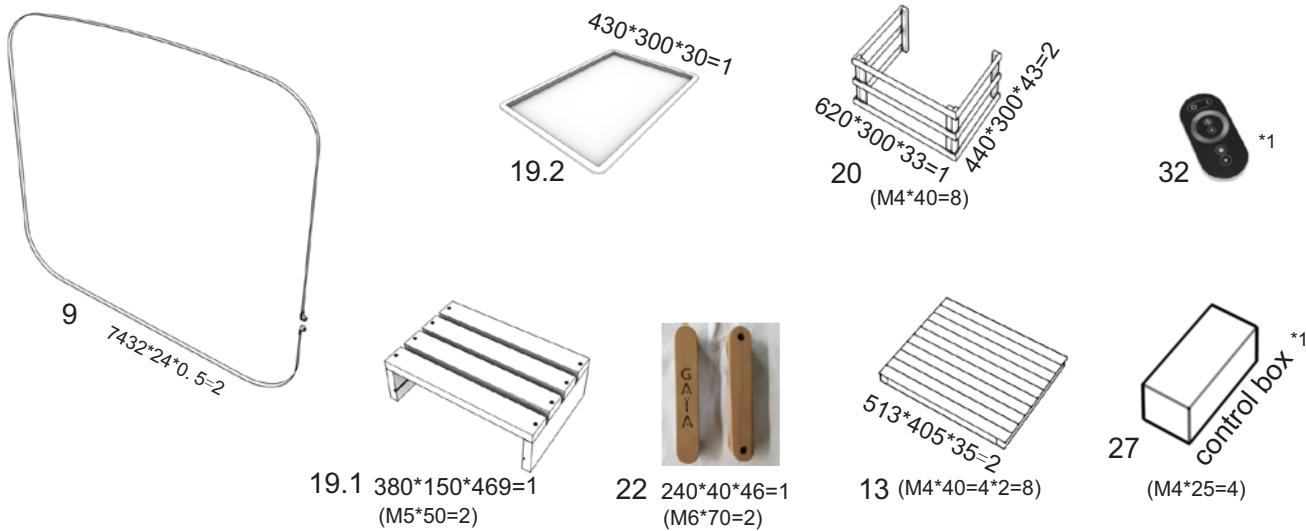
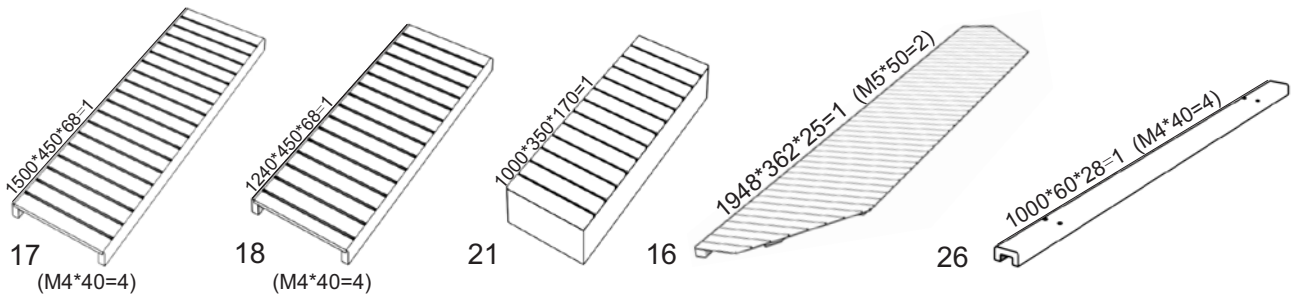
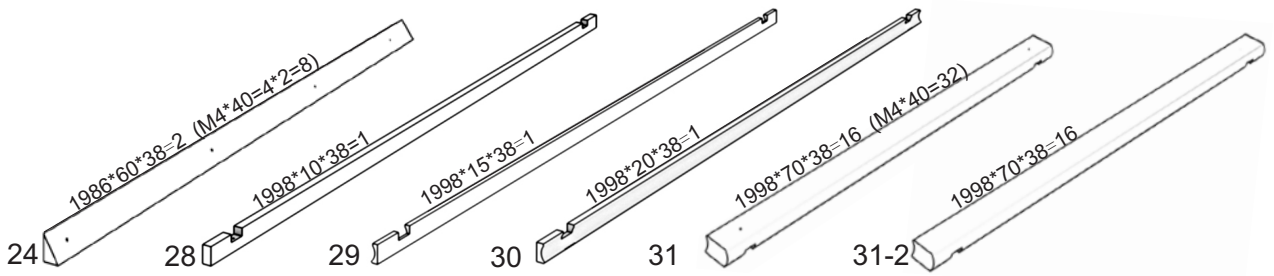
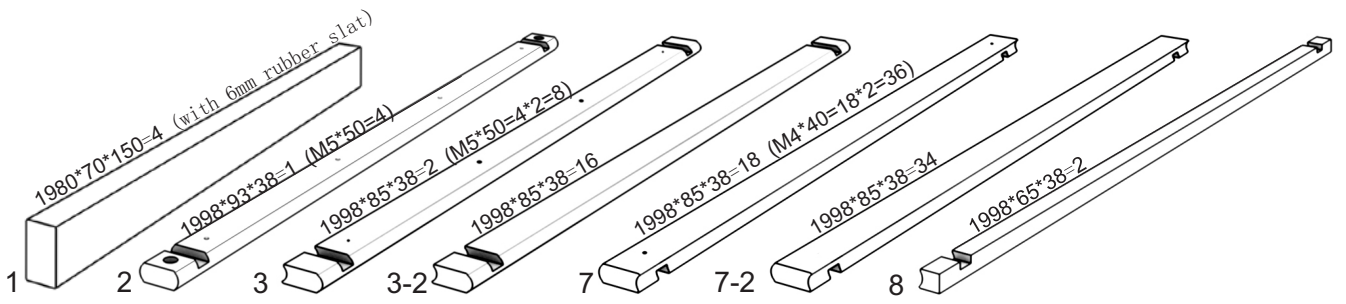

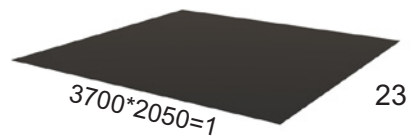
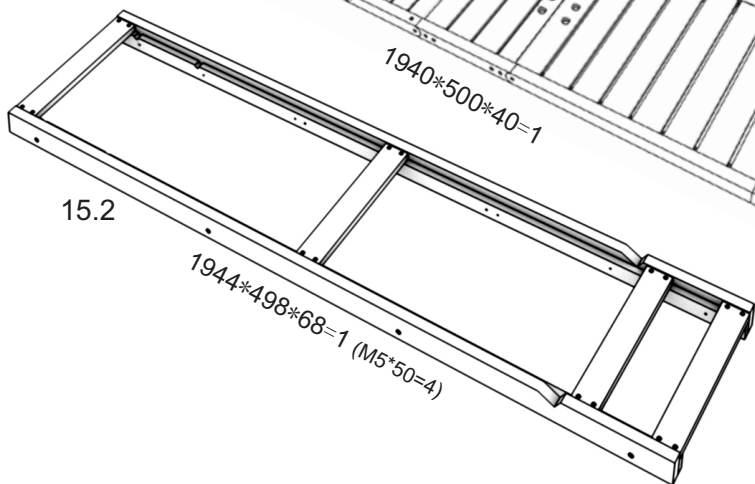
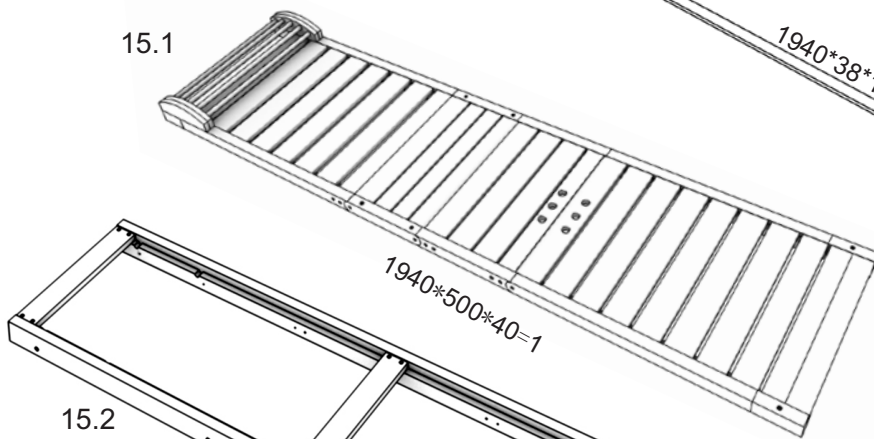
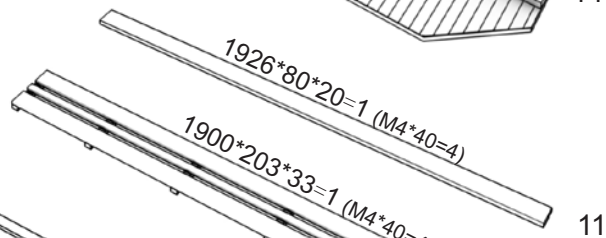
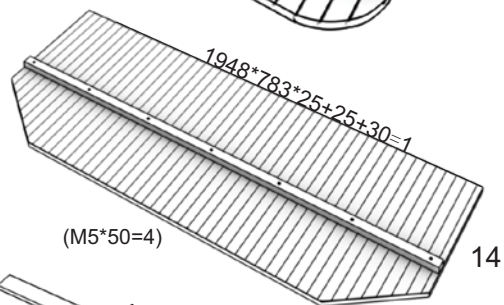
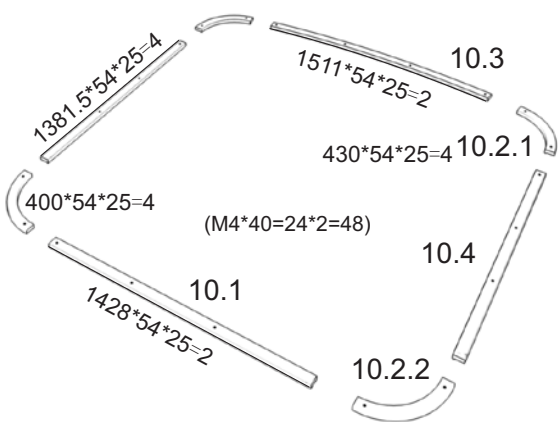
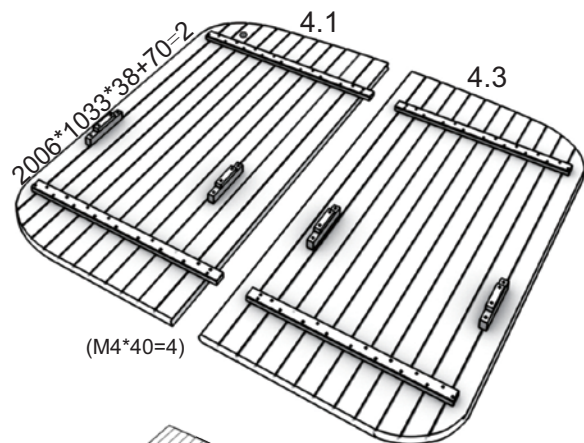
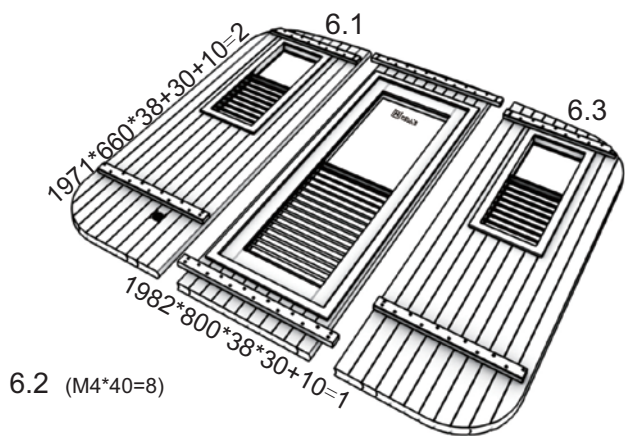

25.3

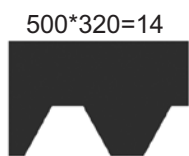

25.2

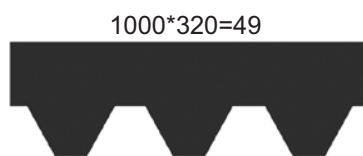

25.1



www.holls.fr

Technical assistance - Assistance technique
Asistencia técnica - Assistenza tecnica
Technische Unterstützung

+33 (0)4 91 51 01 99